



Medium voltage products

UniGear ZS1

Medium voltage, arc-proof, air insulated switchgear up to 24 kV insulated voltage

Index

- 1. UniGear ZS1**
 - 4 Description
 - 8 IEC Classification
 - 10 Design features
 - 12 Fully type tested
 - 14 Safety
 - 18 Vacuum circuit-breaker
 - 22 Gas circuit-breaker
 - 24 Vacuum contactor
 - 26 Switch-disconnector
 - 28 Service trucks
 - 30 UFES - Ultra fast earthing switch
 - 32 Is-limiter fault-current limitation
 - 34 Instrument transformers
 - 36 Measurement sensors
 - 40 Cable terminations
 - 42 Distribution automation
 - 56 Automatic transfer system
 - 58 Typical units
 - 60 Technical data

- 2. UniGear ZS1 - Double Busbar System**
 - 64 Description
 - 66 Characteristics
 - 68 Typical units
 - 70 Technical data

- 3. Marine Applications**
 - 74 Description
 - 76 Characteristics
 - 78 Typical units
 - 80 Technical data

- UniGear ZS1 - Double Level**
 - 82 Description
 - 84 Characteristics
 - 86 Typical units
 - 88 Technical data

1. UniGear ZS1 Description

- UniGear ZS1 is the ABB mainline global switchgear up to 24 kV, 4000 A, 50 kA and is produced close to you in all the six continents
- More than 150,000 panels produced and installed in more than 100 countries
- Each UniGear ZS1 panel consists of a single unit which can be equipped with a circuit-breaker, contactor or switch-disconnector, as well as with all the accessories available for conventional switchgear units



- Approved to be used for special applications such marine, seismic, nuclear and type tested for IEC, GB/DL, GOST and CSA standards
- Units can be coupled together directly with the other products of the UniGear family
- The switchgear does not require rear access for installation or maintenance, all the operations are carried out from the front



Characteristics of UniGear ZS1

Range

- Up to 12-17.5 kV, ...4000 A, ...50 kA
- Up to 24 kV, ...3150 A, ...31.5 kA
- Standard IEC
- Highly customized versions

Safety

- Fitted with safety interlocks
- Internal arc classification IAC AFLR
- Classified LSC-2B, PM
- CB racking with closed door

Flexibility

- Wide applications
- Vacuum and SF6 circuit-breaker
- Vacuum contactor
- Switch-disconnector
- Traditional CT/VT and sensors
- Wall and free-standing solution

Quality

- ABB quality
- Large installed base
- Installed in high number of countries

Design includes

- Protection and control
- Earthing switch
- Ultra fast earthing switch
- IS Limiter
- Integrated capacitor banks
- Bay computer

Applications

Utilities and Power Plants

- Power generation stations
- Substations
- Main and auxiliary switchgear

Industry

- Pulp and Paper
- Cement
- Textiles
- Food
- Automotive
- Quarrying
- Petrochemical
- Oil and gas
- Metallurgy
- Rolling mills
- Mines

Marine

- Drilling platforms
- Off-shore oil rigs
- Cruise ships
- Container ships
- Tankers
- Cable ships
- Ferries

Transport

- Airports
- Ports
- Railways
- Underground transport

Infrastructure

- Shopping malls
- Hospitals
- Large infrastructure and civil works

1. UniGear ZS1 Description

UniGear ZS1 is medium voltage switchgear with a metal enclosure, suitable for indoor installations.

Metal partitions segregate the compartments from each other and the live parts are air-insulated.

Since the switchgear is highly modular type, this make simple selection of components required by any application.

The functional units of the switchgear are guaranteed arc proof in accordance with the IEC 62271-200 Standards, appendix AA, class A accessibility, criteria 1 to 5.

All the installation, operation and maintenance operations can be carried out from the front of the unit.

The switchgear and the earthing switches are operated from the front with the door closed.

The switchgear can be back to wall installed.



Apparatus

The range of apparatus available for UniGear ZS1 switchgear is the most complete on the market, including:

- withdrawable vacuum circuit-breakers with mechanical or magnetic actuator,
- withdrawable gas circuit-breakers,
- withdrawable vacuum contactors with fuses,
- fixed version of switch-disconnectors.

This makes it possible to offer a single switchgear-user interface, with the same operational and maintenance procedures.

The switchgear can be fitted with instrument transformers or sensors for current and voltage measurement and protection and any type of protection and control unit.

Switchgear, busbar configuration

In the completion of the traditional functional units in single level-single busbar arrangement, the UniGear ZS1 switchgear platform is fitted with:

- Double-level,
- Compact units equipped with contactors with fuses,
- Double Busbar Systems.

The use of these units allows extremely efficient use of space. In addition UniGear ZS1 single busbar is possible to combine to other members of UniGear family like:

- UniGear 550,
- UniGear 500R,
- UniGear MCC.

Normal operation conditions

The rated characteristics of the switchgear are guaranteed under the following ambient conditions:

- minimum ambient temperature: $-5\text{ }^{\circ}\text{C}$
- maximum ambient temperature: $+40\text{ }^{\circ}\text{C}$

For different temperature ranges, please contact your ABB sales representative.

- Ambient humidity:
 - maximum 24 h average of relative humidity 95% RH
 - maximum 24 h average of water vapour pressure 2.2 kPa
 - maximum monthly average of relative humidity 90% RH
 - maximum monthly average of water vapour pressure 1.8 kPa
- The normal operational altitude is up to 1,000 m above sea level. For higher altitude applications, please contact your ABB sales representative.
- Presence of normal, non-corrosive and uncontaminated atmosphere.

Standards

The switchgear and main apparatus contained in it comply with the following Standards:

- IEC 62271-1 for general purposes.
- IEC 62271-200 for the switchgear.
- IEC 62271-102 for the earthing switch.
- IEC 62271-100 for the circuit-breakers.
- IEC 60071-2 for the insulation coordination.
- IEC 60470 for the contactors.
- IEC 60265-1 for the switch-disconnectors.
- IEC 60529 for degree of protections.

Colour of the external surfaces

RAL7035 - light grey (front doors and side sheets).
Other colours available on request.

Degrees of protection

The degrees of protection of the switchgear conform with IEC 60529 Standards.

UniGear ZS1 switchgear is normally supplied with the following standard degrees of protection:

- IP4X for the enclosure.
- IP2X for the partition between compartments.

On request, the external housing can be supplied with a higher degree of protection; in this case please contact your ABB sales representative.

The electrical characteristics of the switchboard can vary for ambient conditions other than those described in the previous section and also if a higher degree of protection is used.

IEC electrical characteristics of UniGear ZS1 - Single Busbar System

Rated voltage	kV	7.2	12	17.5	24
Rated insulation voltage	kV	7.2	12	17.5	24
Rated power frequency withstand voltage	kV 1min	20	28	38	50
Rated lightning impulse withstand voltage	kV	60	75	95	125
Rated frequency	Hz	50/60	50/60	50/60	50/60
Rated short time withstand current	kA 3 s	..50	..50	..50	..31.5
Peak current	kA	..125	..125	..125	..80
Internal arc withstand current	kA 1 s	..50	..50	..50	..31.5
Main busbar rated current	A	..4,000	..4,000	..4,000	..3,150
		630	630	630	630
		1,250	1,250	1,250	1,250
Circuit-breaker rated current	A	1,600	1,600	1,600	1,600
		2,000	2,000	2,000	2,000
		2,500	2,500	2,500	2,300
		3,150	3,150	3,150	2,500
Circuit-breaker rated current with forced ventilation	A	3,600	3,600	3,600	2,500
		4,000	4,000	4,000	3,150

- 1) For other versions, please refer to the chapters no. 2 (Double Busbar System) and chapter no. 3 (Marine Applications).
- 2) GB/DL version is available with higher request in dielectric characteristics (42 kV) and short time withstand current (4 s).
- 3) The values indicated are valid for both vacuum and SF6 circuit-breaker.
- 4) For panel with contactor the rated current value is 400 A.
- 5) CSA version is available for 27,6 kV.

1. UniGear ZS1 IEC Classification

With the release of the IEC 62271-200 standard, new definitions and classifications of Medium Voltage switchgear have been introduced.

One of the most significant changes is that classification of switchgear into metal-enclosed, compartmented and cubicle types has been abandoned.

The revision of switchgear classification rules has been based on the user's point of view, in particular on aspects like service and maintenance of the switchgear, according to the requirements and expectations for proper management, from installation to dismantling.

In this context, Loss of Service Continuity (LSC) has been selected as a fundamental parameter for the user.

According to the IEC 62271-200, UniGear ZS1 switchgear can be defined as follows.

Loss of service continuity - LSC-2B

The various LSC categories describe the possibility of keeping other compartments and/or panels energized while a compartment in the main circuit is opened. The defined categories are:

- **LSC-1:** The whole switchgear shall be put out of service for opening a main circuit compartment for normal operation and/or normal maintenance or for gaining access to any switchgear components.
- **LSC-2A:** The same as LSC-1 with the exception that the main busbars and the functional units adjacent to the one under maintenance can remain energized.
- **LSC-2B:** The same as LSC-2A with the exception that the cable compartment can remain energized.

UniGear ZS1 is classified as LSC-2B because the busbar, circuit-breaker and cable compartments are physically and electrically segregated. This is the category that defines the possibility of accessing the circuit-breaker compartment with the busbars and cables energized. In case of using the fixed version of the switch-disconnector, the panel is defined LSC-2A because the cable and apparatus compartments are not physically segregated.

Partition Metallic - PM

With regard to the type of partitions or shutters between live parts and an open compartment, a distinction is made between two partition classes:

- Class PM (Partition made of Metal);
- Class PI (Partition made of Insulating material).

UniGear ZS1 is defined with PM partition class having the segregation between compartments made of metallic sheets/shutters.

Interlock-controlled accessible compartment

The front side of UniGear ZS1 is classified interlock-controlled because the access of the compartments containing high-voltage parts, intended to be opened for normal operation and/or normal maintenance, is controlled by the integral design of the switchgear.

Tool-based accessible compartment

The rear part of the UniGear ZS1 is classified tool-based because it is possible to open the compartment containing high-voltage parts, that may be opened, but not for normal operation and maintenance, only using a tool. Special procedures are required.

Internal arc classification – IAC AFLR

UniGear ZS1 switchgear is classified IAC AFLR.

When the switchgear is specified and installed, some fundamental points must be taken into consideration:

- Level of the fault current (16...50 kA).
- Duration of the fault (0.1...1s).
- Escape routes for the hot and toxic gases produced by combustion of materials.
- Dimensions of the room, with special attention to the height.

Please consult your ABB representatives for detailed information.



1. UniGear ZS1

Design features

Compartments

Each switchgear unit consists of three power compartments: circuit-breaker [A], busbars [B] and cables [C]; please refer to figure 1.

Each unit is fitted with a low voltage compartment [D], where all the auxiliary instruments are housed.

Arc-proof switchgear is normally provided with a duct [E] for evacuation of the gases produced by an arc; different types of gas ducts are available.

All the compartments are accessible from the front and maintenance operations can correctly be carried out with the switchgear installed up against a wall.

The compartments are segregated from each other by metallic partitions.

Main busbars

The busbar compartment contains the main busbar system connected to the upper isolating contacts of the circuit-breaker by means of branch connections.

The main busbars are made of electrolytic copper.

For ratings up to 2500 A, the busbars are flat bars; while for currents between 3150 A and 4000 A, a special D-shape busbar is used.

The busbars are covered with insulating material.

There is a single busbar compartment along the whole length of the switchgear up to 31,5 kA, which optionally can be divided into compartments. For 40/50 kA these bushings are a standard feature.

Cable connections

The cable compartment contains the branch system for connection of the power cables to the lower contacts of the circuit-breaker.

The feeder connections are made of electrolytic copper and they are flat busbars for the whole range of currents.

For 17.5 and 24 kV they are covered with insulating material.

Earthing switch

Cable compartment can be fitted with an earthing switch for cable earthing.

The same device can also be used to earth the busbar system (measurements and bus-tie units).

It can also be installed directly on the main busbar system in a dedicated compartment (busbar applications).

The earthing switch has short-circuit making capacity.

Control of the earthing switch is from the front of the switchgear with manual operation, and optionally, can also be motor operated.

The position of the earthing switch can be seen from the front of the switchgear by means of a mechanical coupled indicator.

Earthing busbar

The earthing busbar is made of electrolytic copper and it runs longitudinally throughout the switchgear, thereby guaranteeing maximum personnel and installation safety.

Insulating bushings and shutters

The insulating bushings in the circuit-breaker compartment contain the contacts for connection of the circuit-breaker with the busbar compartment and cable compartment respectively. The insulating bushings are of single-pole type and are made of epoxy resin. The shutters are metallic and are activated automatically during movement of the circuit-breaker from the racked-out position to the operation position and vice versa.

Cables

Single and three-core cables up to a maximum of twelve per phase can be used depending on the rated voltage, the unit dimensions and the cable cross section (please refer to page 40).

The switchgear can be back to wall installed as the cables are easily accessible from the front.

Gas exhaust duct

The gas exhaust duct is positioned above the switchgear and runs along its whole length.

Each power compartment is fitted with a flap on its top surface. The pressure generated by the fault makes it open, allowing the gas to pass into the duct.

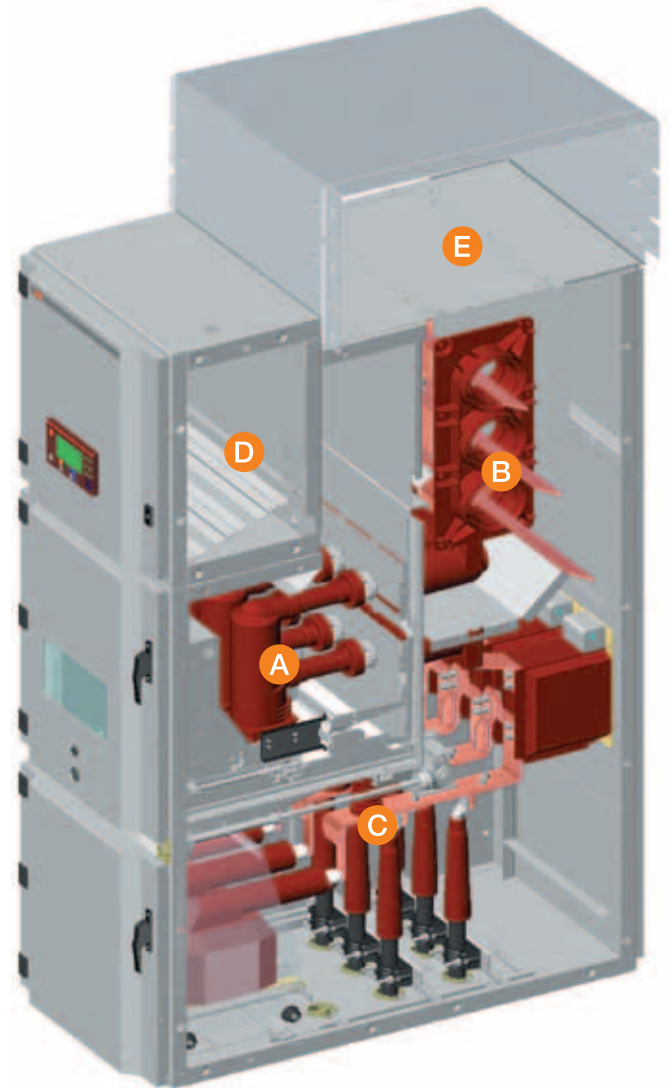
Evacuation from the room of the hot gases and incandescent particles produced by the internal arc must normally be carried out. The UniGear ZS1 switchgear can be fitted with a complete range of solutions to satisfy all requirements, either in the case where evacuation is possible directly at the end of the switchgear, or when solutions from the front or rear are requested.

Some installations, such as marine applications, do not allow evacuation of the gases to the outside of the room and therefore a dedicated solution has been developed to guarantee personnel safety and conformity with the Standards, such as longitudinal evacuation chimneys. Please contact your ABB sales representative for more information.

Busbar applications

Each switchgear unit can optionally be fitted with an accessory busbar application:

- current or voltage transformers for busbar measurements.
- busbar system earthing switch.
- top entry duct or cables to make interconnections between different sections of switchgear.



Unit compartments

- A Circuit-breaker compartment
- B Busbar compartment
- C Cable compartment
- D Low voltage compartment
- E Compact gas duct channel

Figure 1: UniGear ZS1 single level section view

1. UniGear ZS1

Fully type-tested

The UniGear ZS1 switchgear has undergone all the tests required by the international (IEC) Standards and local Standards organizations (for example, the Chinese GB/DL and Russian GOST standards).

In addition, the tests required by the main shipping registers (LR, DNV, RINA, BV and GL) have been carried out for use of the switchgear in marine installations.

As indicated in these standards, the tests were carried out on the switchgear units considered most sensitive to the effects of the tests and therefore the results were extended across the whole range.

Each switchgear unit is subjected to routine tests in the factory before delivery.

These tests are intended to provide a functional check of the switchgear based on the specific characteristics of each installation.

IEC type tests

- Short-time and peak withstand current
- Temperature rise
- Internal arc capability
- Dielectric test
- Making and breaking capacity of circuit-breaker and contactors
- Earthing switch making capacity
- Mechanical operations of circuit-breaker and earthing switch
- IP protection degree

IEC routine factory tests

- Visual inspection and check
- Mechanical sequence operations
- Cabling check
- Electrical sequence operations
- Power frequency withstand voltage
- Measurement of the resistance of the main circuits
- Secondary insulation test

Special type tests required by shipping registers for marine application

- High ambient temperatures (+ 45 °C)
- Inclination
- Vibration

Description of IEC type tests

• Short-time and peak withstand current

The test shows that the main power and the earthing circuits resist the stresses caused by the passage of the short-circuit current without any damage.

It should also be noted that both the earthing system of the withdrawable circuit-breaker and the earthing busbar of the switchgear are subjected to the test.

The mechanical and electrical properties of the main busbar system and of the top and bottom branch connections remain unchanged even in the case of a short-circuit.

• Temperature rise

The temperature rise test is carried out at the rated current value of the switchgear unit and shows that the temperature does not become excessive in any part of the switchgear unit. During the test, both the switchgear and the circuit-breaker or contactor it may be fitted with are checked.

• Internal arc capability

Please refer to page 14.

• Dielectric test

These tests verify that the switchgear has sufficient capability to withstand the lightning impulse and the power frequency voltage.

The power frequency withstand voltage test is carried out as a type test, but it is also a routine test on every switchgear unit manufactured.

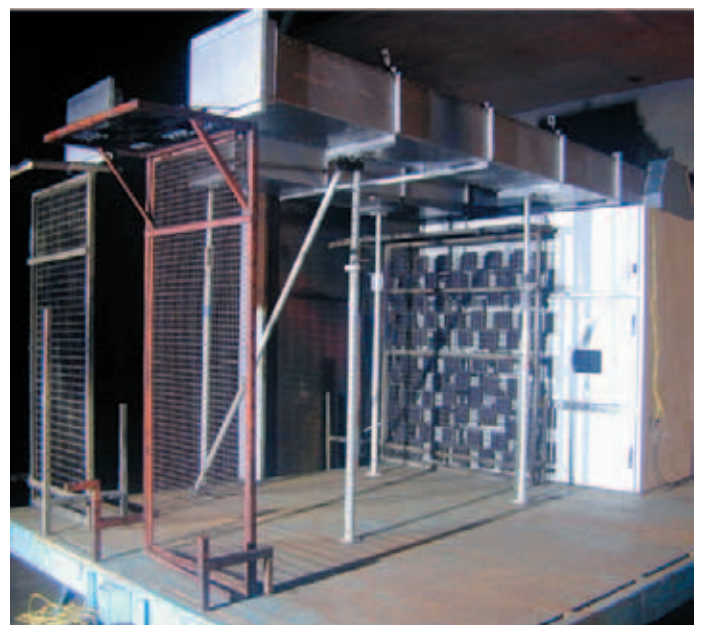


Figure 2: UniGear ZS1 during internal arc test

- **Circuit-breaker making and breaking capacity**

The circuit-breaker or contactor is subjected to the rated current and short-circuit current breaking tests.

Furthermore, it is also subjected to the opening and closing of capacitive and inductive loads, capacitor banks and/or cable lines.

- **Earthing switch making capacity**

The earthing switch of the UniGear ZS1 switchgear can be closed under short-circuit. Although, the earthing switch is normally interlocked to avoid being operated on circuits which are still live.

However, should this happen for any one of several reasons, personnel safety would be fully safeguarded.

- **Mechanical operations**

The mechanical endurance tests on all the operating parts ensures the reliability of the apparatus. General experience in the electro-technical sector shows that mechanical faults are one of the most common causes of a fault in an installation. The circuit-breaker is tested by carrying out a high number of operations - higher than those which are normally carried out by installations in the field.

Furthermore, the switchgear components are part of a quality control program and samples are regularly taken from the production lines and subjected to mechanical life tests to verify that the quality is identical to that of the components subjected to the type tests.

- **IP protection degree**

The IP protection degree is the resistance offered by the UniGear ZS1 against penetration of solid objects and liquids. This degree of resistance is indicated by the prefix IP followed by two characters (i.e. IP4X).

The first number identifies the degree of protection against the entrance of solid objects, the second one is related to liquids.

Type tests required by the shipping registers

- **High ambient temperature**

The service conditions for the electrical apparatus in marine installations are generally more severe than those in normal land applications.

Temperature is a main factor and for this reason the shipping register regulations require the switchgear to be able to operate at higher ambient temperatures (45 °C or higher) than those stated in the IEC Standards (40 °C).

- **Inclination**

The test is carried out by inclining the switchgear for a defined time up to 25° alternately on all four sides and operating the apparatus.

The test proves that the switchgear is able to resist these extreme service conditions and that all the apparatus it contains can be operated without any problems and without being damaged.

- **Vibration**

The reliability and sturdiness of the UniGear ZS1 switchgear has been definitively proved by the result of the withstand test to mechanical stresses due to vibration. The service conditions on shipping installations and marine platforms require the switchgear to work in environments strongly affected by vibrations, such as those caused by the motors on large cruise ships or the drilling plants of oil rigs.

- 1 mm amplitude in the frequency range between 2 and 13.2 Hz.
- 0.7 g acceleration amplitude in the frequency range between 13.2 and 100 Hz (see picture on the previous page).



Figure 3: inclination test



Figure 4: vibration/seismic test

1. UniGear ZS1 Safety

When developing modern medium voltage switchgear, personnel safety must necessarily take priority. This is why the UniGear ZS1 switchgear has been designed and tested to withstand an internal arc due to a short-circuit current of the same current level as the maximum short-time withstand level.

The tests show that the metal housing of UniGear ZS1 switchgear is able to protect personnel near the switchgear in the case of a fault which evolves as far as striking an internal arc.

An internal arc is a highly unlikely fault, although it can theoretically be caused by various factors, such as:

- Insulation defects due to quality deterioration of the components. The reasons can be adverse environmental conditions and a highly polluted atmosphere.
- Overvoltages of atmospheric origin or generated by the operation of a component.
- Inadequate training of the personnel in charge of the installation.
- Breakage or tampering of the safety interlocks.
- Overheating of the contact area, due to the presence of corrosive agents or when the connections are not sufficiently tightened.
- Entry of small animals into the switchgear (i.e. through cable entrance).
- Material left behind inside the switchgear during maintenance activities.

The characteristics of the UniGear ZS1 switchgear notably reduce the incidence of these causes for faults, but some of them may not be eliminated completely.

The energy produced by the internal arc causes the following phenomena:

- Increase in the internal pressure.
- Increase in temperature.
- Visual and acoustic effects.
- Mechanical stresses on the switchgear structure.
- Melting, decomposition and evaporation of materials.

Unless suitably protected, these phenomena have very serious consequences for the personnel, such as wounds (due to the shock wave, flying parts and the doors opening) and burns (due to emission of hot gases).

The internal arc test verifies that the compartment doors remain closed and that no components are ejected from the switchgear even when subjected to very high pressures, and that no flames or incandescent gases penetrate, thereby ensuring safety of the personnel near the switchgear.

The test also ensure that no holes are produced in external accessible parts of the housing, and finally, that all the connections to the earthing circuit remain intact, hence guaranteeing the safety of personnel who may access the switchgear after the fault.

The IEC 62271-200 Standard describes the methods to be used for carrying out the test and the criteria which the switchgear must conform to.

The UniGear ZS1 switchgear fully conforms to all the five criteria indicated by the IEC standards.

The IAC classification is proved by the test according to the following designations:

- General: classification IAC (Internal Arc Classified)
- Accessibility: A, B or C (switchgear accessible to authorized personnel only (A), to all (B), not accessible due to installation (C))
- F, L, R: access from the front (F – Front), from the sides (L – Lateral) and from the rear (R – rear).
- Test values: test current in kiloamperes (kA), and duration in seconds (s).

The parameters of each specific plant mean that evacuation of the hot gases and incandescent particles must be checked very carefully in order to ensure and maintain personnel safety.

Fault limiting systems

The structure of the UniGear ZS1 switchgear offers complete passive type protection against the effects of a fault due to an internal arc for a time of 1 second up to 50 kA.

ABB has also developed excellent active protection systems which allow very important objectives to be achieved:

- Detection and extinction of the fault, normally in less than 100 ms, which improves network stability.
- Limitation of damage on the apparatus.
- Limitation of outage time for the switchgear unit.

For active protection against an internal arc, devices consisting of various types of sensors can be installed in the various compartments, which detect the immediate outburst of the fault and carry out selective tripping of the circuit-breakers.

The fault limiting systems are based on sensors which use the pressure or light generated by the arc fault as trigger for fault disconnection.

ITH

The ITH sensors consist of micro-switches positioned on the top of the switchgear near the gas exhaust flaps of the three power compartments (busbars, circuit-breaker and cables). The shock wave makes the flaps open and operate the micro-switches connected to the shunt opening release of the circuit-breaker.

Total tripping time is 75 ms (15 ms ITH + 60 ms circuit-breaker).

FRD (Fast Recovery Device)

This system consists of pressure sensors located in the low voltage compartment and connected to the three power compartments by means of small tubes.

The sensors detect the rising front of the pressure wave which develops on the outburst of the arc and react by making the circuit-breakers open.

The sensors are protected against the external environment and they can be checked even with the switchgear in operation.

Total tripping time is 75 ms (15 ms FRD + 60 ms circuit-breaker).

TVOC

This system consists of an electronic monitoring device located in the low voltage compartment which is connected to optic sensors. These are distributed in the power compartments and are connected to the device by means of optic fibres.

When a certain pre-set light level is exceeded, the device opens the circuit-breakers.

To prevent the system from intervening due to light occasionally generated by external phenomena (flash of a camera, reflections of external lights, etc.), current transformers can also be connected to the monitoring device.

The protection module only sends the opening command to the circuit-breaker if it receives the light and short-circuit current signal simultaneously.

Total tripping time is 62 ms (2 ms TVOC + 60 ms circuit-breaker).

REA

This system offers the same functionality as TVOC. The REA system consists of the main unit (REA 101) and optional extension units (REA 103, 105, 107) which make it possible to create customized solutions with selective tripping. For more information, please see the dedicated chapter at page 50.

Total tripping time is 62,5 ms (2,5 ms REA + 60 ms circuit-breaker).

Arc protection in IED

The REF615, RET615, REM615 and REF610 IEDs (Intelligent Electronic Device) can optionally be fitted with a fast and selective arc flash protection. It offers a two-to three-channel arc-fault protection system for arc flash supervision of the circuit breaker, cable and busbar compartment of switchgear panels.

Total tripping time is 72 ms (12 ms IED + 60 ms circuit-breaker).

UFES (ultra fast earthing switch)

The UFES is an innovative design of an extremely fast-acting earthing switch, grounding all 3 phases within < 4 ms after detection of an internal arc fault.

For more information please see the dedicated chapter at page 30.

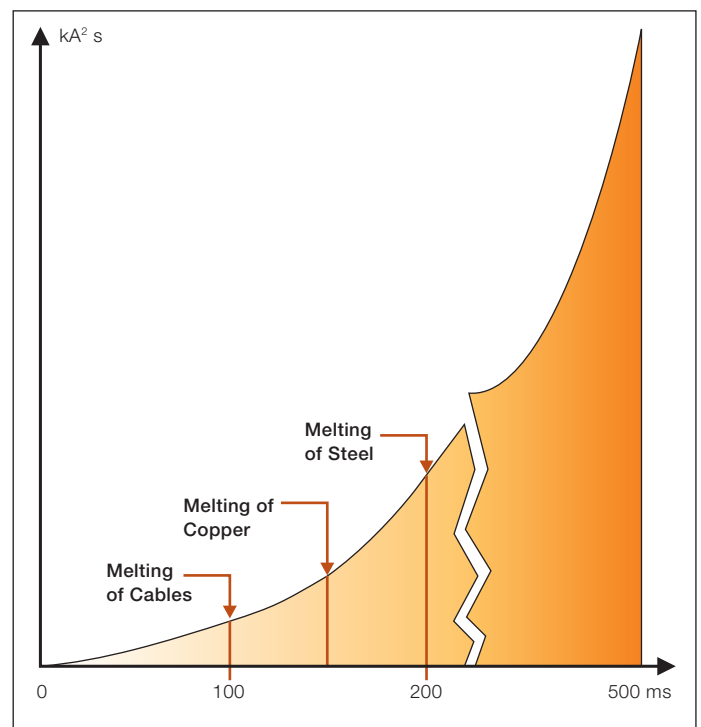


Figure 5: Arc duration and damage caused

1. UniGear ZS1 Safety

The UniGear ZS1 switchgear is fitted with all the interlocks and accessories needed to guarantee the highest level of safety and reliability for both installation and personnel.

Interlocks

The safety mechanical interlocks are standard ones [1 ÷ 5], please see the dedicated table at page 17. They are set out by the IEC standards and are therefore necessary to guarantee the correct operation sequence. ABB safety interlocks guarantees the highest level of reliability, even in the case of an accidental error, and enables highest operator safety system of interlocks.

Keys

The use of key interlocks is very important in realising the interlocking logics between panels of the same switchgear, or of other medium, low and high voltage switchgear. The logics are realised by means of distributors or by ringing the keys. The apparatus truck [6] can be locked in the racked-out position and the relevant lock key can only be removed with the apparatus in this position. The earthing switch closing [7] and opening [8] operations can be locked by means of keys, key logic is explained in the table at page 15. These locks can also be applied to the earthing switch of busbar applications. The circuit-breaker racking-in/out operations [9] and earthing switch opening/closing [10] can be prevented by means of key locks, which prevent insertion of the relevant operating levers. The key lock can also be applied to the earthing switch of busbar applications. The keys can always be removed.

Padlocks

The circuit-breaker [11] and cables [12] compartment doors can be locked in the closed position by means of padlocks. These can be applied to both door closing versions –with central handle (standard) or screws (optional). The operations for apparatus racking-in/out [13] and earthing switch opening/closing [14] can be prevented by applying the padlocks to the insertion slots of the relevant operating levers.



Figure 6: Double key lock on earthing switch

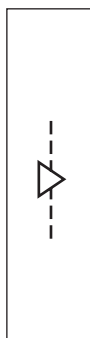
The padlock can also be applied to the earthing switch of busbar applications. The metallic segregation shutters [15] between circuit-breaker, busbars and cables compartments can be locked by means of two independent padlocks in both the open and closed positions. Padlocks from 4 to 8 mm diameter can be accommodated.

Locking magnets

The locking magnets enable automatic interlocking logics without human intervention. The circuit-breaker racking-in/out [16] and the earthing switch closing/opening [17] operations can be interlocked. This magnet can also be applied to the earthing switch of busbar applications. The magnets operate with active logics and therefore the lack of auxiliary voltage leaves the interlocking system active in safety condition.

Types of interlocks

Standard safety interlocks (mandatory)



Type	Description	Condition to be met
1	A Apparatus racking-in/out	Apparatus in open position
	B Apparatus closing	Defined truck position
2	A Apparatus racking-in	Apparatus multi-contact plug plugged
	B Apparatus multi-contact plug unplugging	Truck in test position
3	A Earthing switch closing	Truck in test position
	B Apparatus racking-in	Earthing switch in open position
4	A Apparatus compartment door opening	Truck in test position
	B Apparatus racking-in	Apparatus compartment door closed
5	A Feeder compartment door opening	Earthing switch in ON position
	B Earthing switch opening	Cable compartment door closed

Note: Apparatus are circuit-breakers and contactors.



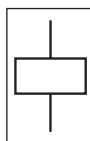
Keys (on request)

6	Apparatus racking-in lock	Can only be removed with the truck in the racked-out position
7	Earthing switch closing lock	Can only be removed with the earthing switch open
8	Earthing switch opening lock	Can only be removed with the earthing closed
9	Insertion of the apparatus racking-in/out crank lever	Can always be removed
10	Insertion of the earthing switch operating lever	Can always be removed



Padlocks

11	Apparatus compartment door opening	
12	Cable compartment door opening	
13	Insertion of the apparatus racking-in/out crank lever	
14	Insertion of the earthing switch operating lever	
15	Shutters opening or closing	



Locking magnets (on request)

16	Apparatus racking-in/out	Magnet energized
17	Earthing switch ON/OFF	Magnet energized

Accessory devices

20	Shutters fail-safe	The device locks the shutters in the closed position when the apparatus is removed from the compartment. The operator cannot open the shutters manually. The shutters can only be operated by the apparatus truck or the service trucks (please see the dedicated chapter at page 28).
21	Apparatus-switchgear unit compatibility matrix	The apparatus multi-contact plug and relative switchgear unit socket are equipped with a mechanical matrix, that disables apparatus racking-in into a switchgear unit with an inappropriate rated current.
22	Circuit-breaker mechanical operating mechanism	The apparatus compartment is equipped with a mechanical device, that enables circuit-breaker closing and/or opening directly by means of the front operating mechanism pushbuttons, keeping the door closed. The controls can be operated with the circuit-breakers in the operation and racked-out position.

1. UniGear ZS1 Vacuum circuit-breaker

UniGear ZS1 switchgear can be fitted with the widest range of apparatus available on the market today, and of these the vacuum circuit-breaker now occupies a position of prime importance in all sectors of primary distribution. Vacuum circuit-breakers cover the whole range of switchgear parameters and therefore the whole range of applications.

Many years of experience gained in developing and using

vacuum interrupters is today reflected in the range of ABB circuit-breakers, which stand out for their exceptional electrical and mechanical characteristics, extremely long life, low maintenance, compactness and the use of highly innovative construction techniques. ABB develops and produces a complete range of interrupters for use in circuit-breakers and contactors and for all medium voltage applications.



Figure 7: UniGear ZS1

VD4 circuit-breaker

The VD4 medium voltage circuit-breaker interrupters use vacuum to extinguish the electric arc and as the insulating medium.

Thanks to the unequalled properties of vacuum and the breaking technique used, current interruption takes place without arc chopping and without overvoltages. Restoration of the dielectric properties following interruption is extremely rapid.

The VD4 circuit-breakers are used for protection of cables, overhead lines, motors, transformers, generators and capacitor banks.

Poles

The VD4 medium voltage circuit-breakers use vacuum interrupters embedded in poles (¹).

Embedding the interrupter in the pole makes the circuit-breaker particularly sturdy and protects the interrupter itself against shocks, deposits of dust and humidity.



Figure 8: VD4 circuit-breaker with mechanical actuator

The vacuum interrupter houses the contacts and provides the interruption chamber.

ABB circuit-breakers use the most advanced vacuum-breaking techniques: with radial magnetic flow for circuit-breakers with medium-low ratings and with axial magnetic flow for those with high breaking capacity.

Both techniques guarantee even distribution of the arc roots over the whole surface of the contacts, allowing optimum performance at all current values.

The structure of a vacuum interrupter is relatively simple. The housing is made up of a ceramic insulator closed at the ends by stainless steel covers. The contacts are made of pure copper and sintered chrome and are welded to the copper terminals. A metallic bellows allows movement of the moving contact-terminal group, at the same time guaranteeing that the vacuum is maintained in the interrupter. The interrupter components are welded in an environment under a very strong vacuum to guarantee a vacuum of less than 10^{-5} Pa in the interrupter.

This means that the interrupter does not any ionisable material. In any case, on detachment of the contacts, an electric arc is generated which only consists of the melted and vaporised material of the contact.

A metallic shield is integrated inside the interrupter to capture the metallic vapours given off during interruption, as well as for controlling the electric field. The particular shape of the contacts generates a magnetic field which forces the arc to rotate and to involve a much wider surface than that of a fixed contact arc.

Apart from limiting the thermal stress on the contacts, this makes contact erosion negligible and, above all, allows the interruption process to be controlled even with very high short-circuit currents.

The electric arc remains supported by the external energy until the current passes through its natural zero.

The ABB vacuum interrupters are zero current interrupters and are free of any re-striking phenomena.

The rapid reduction of the current density and fast condensation of the metallic vapours, that happens at the instant that the current passes through zero, allow the maximum dielectric strength between the interrupter contacts to be re-established within a few milliseconds. Supervision of the vacuum level is not necessary as the circuit-breaker poles are sealed-for-life and do not require any maintenance.

(¹) Circuit-breakers up to 17.5 kV - 1250 A - 31.5 kA are made off polyamide poles.

1. UniGear ZS1 Vacuum circuit-breaker

Operating mechanism

The VD4 circuit-breaker is fitted with a mechanical stored energy type operating mechanism.

The trip free mechanism allows opening and closing operations independent of the operator.

The operating mechanism spring system can be recharged either manually or by means of a geared motor. The apparatus can be opened and closed by means of the pushbuttons on the front of the operating mechanism or by means of electric releases (shunt closing, shunt opening and undervoltage). The circuit-breakers are always fitted with an anti-pumping device to eliminate the possibility of simultaneous opening and closing commands, closing commands with springs discharged or with the main contacts not yet in their run-end position.

Truck

The poles and operating mechanism are fixed onto a metal support and handling truck.

The truck is provided with a wheel system which makes the operations for racking the apparatus into and out of the switchgear unit possible with the door closed. The truck allows efficient earthing of the circuit-breaker by means of the metallic structure of the switchgear unit.

The vacuum circuit-breaker truck can be motor-operated. The racking-out and racking-in operations can be carried out by means of electrical controls, either locally by the operator or by a remote system.

Apparatus-operator interface

The front part of the circuit-breaker provides the user interface. It features the following equipment:

- ON pushbutton.
- OFF pushbutton.
- Operation counter.
- Indicator of the circuit-breaker open and closed state.
- Indicator of the charged or discharged state of the operating mechanism springs.
- Manual charging device for the operating mechanism springs.
- Override selector of the undervoltage release (optional).

eVD4 circuit-breaker

The eVD4 circuit-breaker is a complete plug and play medium voltage electrical feeder protection system. It is an evolution of the traditional concept of a circuit-breaker that with a single device, can carry out the breaking, measurement, protection, control and communication functions.

The eVD4 circuit-breaker is derived from the VD4 series with its renowned reliability and robust characteristics.

eVD4 integrates the ABB Relion® family RBX615 series protection device with combined current and voltage sensors.

With this integrated solution, the MTTR – Mean Time to Repair – of the system managed by eVD4 is much lower than traditional solutions. This makes the eVD4 the ideal solution for all installations where a high degree of continuity of service is required.

The eVD4 is available in fixed and withdrawable versions for UniGear ZS1 switchgear and it is mechanically interchangeable with the VD4 circuit-breaker.



Figure 9: eVD4 circuit-breaker with on board sensors, protection and control unit RBX 615.

VM1 circuit-breaker

The conventional mechanical stored energy type of operating mechanism used on the VD4 circuit-breakers can be replaced with an operating mechanism with magnetic actuator, creating the VM1 series of circuit-breakers.

All the characteristics of the circuit-breakers described in this chapter remain unchanged except for the operating mechanism.

The operating mechanism is based on a greatly reduced number of components:

- Actuator with permanent magnets. The heart of the operating mechanism consists of the magnetic actuator which carries out the closing and opening operations, and keeps the main contacts in their positions taken up after the operation. The magnet transmits the operating mechanism to the interrupters by means of a single transmission lever.
- Electronic control device. All the functions (trip, operation, energy charging and watchdog) are carried out by the integrated electronic controller. The circuit-breaker is fitted with a multivoltage direct and alternating current feeder.
- Capacitors. The energy required to switch the operating mechanism is provided by an incorporated capacitor bank. The stored energy guarantees the complete O-C-O reclosing sequence.
- Position sensors. The position of the circuit-breaker contacts is detected by means of electronic proximity sensors.

Standards

IEC 62271-100 for the circuit-breaker.



Figure 10: VM1 circuit-breaker with magnetic actuator

1. UniGear ZS1 Gas circuit-breaker

UniGear ZS1 switchgear can also be fitted with SF6 gas circuit-breakers.

The ABB vacuum and gas series of circuit-breakers are mechanically interchangeable and the same switchgear unit can therefore take either type of apparatus. Only ABB can offer apparatus representing both techniques for the whole range of applications, voltage levels (12-17.5-24 kV), rated current (630...4000 A) and breaking capacity (16...50 kA).

This makes it possible to specify the optimum solution for the installation characteristics and the feeders to be switched and protected.

ABB's long practical experience shows that the two types of circuit-breakers are equally valid and complementary.

HD4 circuit-breaker

The HD4 medium voltage circuit-breakers use sulphurhexafluoride gas (SF6) to extinguish the electric arc and as the insulating medium.

Thanks to the excellent properties of SF6 gas, interruption of the currents takes place without arc chopping and overvoltages. There is no restriking phenomenon after interruption and the dielectric properties following interruption are recovered extremely rapidly.

Gas circuit-breakers are available for all electric power distribution applications. They are particularly recommended for use on capacitor banks, motors, transformers insulated in oil and in installations where components which are particularly sensitive to dielectric and dynamic stresses are installed (for example, old cables or transformers).

Poles

The HD4 circuit-breaker poles use the autopuffer breaking system, combining the compression and self-blast techniques in a single solution.

The autopuffer system is the most innovative technique in the field of gas circuit-breakers and originates from high voltage apparatus.

The combination of the compression and self-blast techniques allows the best performance to be obtained at all current values. Both techniques are always present, but whereas the former operates optimally in switching low currents, the latter acts effectively during operation at higher current values.

The autopuffer technique allows the use of a smaller quantity of gas than that required by circuit-breakers based on other techniques. For the same reason, the gas pressure is also considerably reduced. The autopuffer technique guarantees the insulating withstand voltage and the breaking capacity up to 30% of the rated value, even with zero relative pressure. The whole range of HD4 circuit-breakers uses the same gas pressure for all rated voltage levels (12-17.5-24 kV). SF6 gas pressure level monitoring is not necessary, since the circuit-breaker poles are sealed-for-life pressure systems and are maintenance-free.

They are fitted with a pressure control device for checking that the characteristics are not altered due to transport or incorrect operations.



Fig. 11: HD4 circuit-breaker

Operating mechanism

The HD4 circuit-breaker is fitted with a mechanical stored energy operating mechanism. This is trip free and therefore allows opening and closing operations independent of the operator.

The operating mechanism spring system can be recharged either manually or by means of a geared motor. The operating mechanism is of the same type for the whole series and has a standardised range of accessories and spare parts.

All the accessory components can easily be replaced by means of plug-socket connectors.

Opening and the closing of the apparatus can be carried out by pushbuttons on the front of the operating mechanism or by electric releases (shunt closing, shunt opening and undervoltage).

The circuit-breakers are always fitted with an anti-pumping device to eliminate the possibility of simultaneous opening and closing commands, closing commands with springs discharged or with the main contacts not yet in their run-end position.



Figure 12: HD4-HXA circuit-breaker

Truck

The poles and operating mechanism are fixed onto a metal support and handling truck.

The truck is provided with a wheel system which makes the operations for racking the apparatus out of and into the switchgear unit possible with the door closed.

The truck allows effective earthing of the circuit-breaker by means of the metallic structure of the switchgear unit.

Apparatus-operator interface

The front panel of the circuit-breaker provides the user interface. It features the following equipment:

- ON pushbutton.
- OFF pushbutton.
- operation counter
- indicator of the circuit-breaker open and closed state
- indicator of the charged and discharged state of the operating mechanism springs
- manual charging device for the operating mechanism springs
- override selector of the undervoltage release (optional)
- LED gas pressure indicator (optional)

HD4-HXA circuit-breaker for high unidirectional components

The range of HD4 circuit-breakers is extended by the HD4-HXA version.

This series of circuit-breakers maintains all the features described in this chapter, but is notable for its ability to switch loads with strong unidirectional components.

For breaking capacities of 40 kA or lower, HD4-HXA circuit-breakers are able to switch loads with unidirectional components IDC = 100%, up to service voltage 13.8 kV; at 50 kA the unidirectional component percentage IDC is reduced to 50%. They can be used in all installations affected by strong unidirectional components, but their natural field of application is found in switching and protecting transformers of the auxiliary circuits in power generating stations.

Standards

IEC 62271-100 for the circuit-breaker.

IEC 60376 for the SF6 gas.

1. UniGear ZS1 Vacuum contactor

V-Contact VSC medium voltage contactors are apparatus suitable for operating in alternating current and are usually used to control feeders which require a high number of operations per hour.

They are suitable for operating and protecting motors, transformers and power factor correction banks.

Fitted with appropriate fuses, they can be used in circuits with fault levels up to 1000 MVA.

The electrical life of V-Contact VSC contactors is defined as being in category AC3 with 100,000 operations (closing/opening), 400 A interrupted current.

V-Contact VSC contactor

The contactors consist of a monobloc of resin containing the following components:

- vacuum interrupters
- moving equipment
- magnetic actuator
- multivoltage feeder
- accessories and auxiliary contacts.

The V-Contact contactors are provided in the following versions:

- VSC7/P for voltages up to 7.2 kV.
- VSC7/PG for voltages up to 7 kV with 32 kV power frequency withstand voltage.
- VSC12/P for voltages up to 12 kV.
- VSC12/PG for voltages up to 12 kV with 42 kV power frequency withstand voltage.



Figure 13: V-Contact VSC contactor

Both versions are available with an operating mechanism with electrical or mechanical latching.

The V-Contact VSC contactors are mechanically interchangeable with the former V-Contact V/P contactor and with the whole series of ABB circuit-breakers, the same switchgear unit can therefore take both types of apparatus without modification.

A version of V-Contact VSC contactors is also used in the UniGear MCC compact switchgear up to 400 A.

Operating mechanism

Due to the magnetic actuator, V-Contact VSC contactors need negligible auxiliary power in all configurations (15W inrush - 5W continuous).

The V-Contact VSC is available in three different configurations.

- SCO (single command operation).

The contactor closes the supply of auxiliary voltage to the multivoltage feeder input, when the auxiliary is cut the contactor opens.

- DCO (double command operation).

The contactor closes the supply of auxiliary voltage to the multivoltage feeder closing input and opens when opening input is supplied; anti pumping function is supplied as a standard.

- DCO configuration is also available, on request, with a delayed undervoltage function. This function enables automatic opening of the contactor when the auxiliary voltage level drops below IEC defined levels.

Opening can be delayed from 0 to 5 seconds (customer setting by dip switches).

All configurations are suitable for 1,000,000 mechanical operations.

Fuses

The contactor is fitted with medium voltage fuses for protection of the operated feeders.

Coordination between the contactor, fuses and protection unit is guaranteed in accordance with the IEC 60470 Standards for apparatus in class C.

The fuse-holder frame is usually preset for installation of a set of three fuses per phase with average dimensions and type of striker, according to the following Standards:

- DIN 43625.
- BS 2692.

The following fuses can be applied:

- DIN type with a length of 192, 292 and 442 mm
- BS type with a length of 235, 305, 410, 454 and 553 mm.

The fuse-holder frames are fitted with a device for automatic opening when even just one fuse blows.

This same device does not allow contactor closing when even a single fuse is missing.

The ABB range of fuses for transformer protection is called CEF, whereas CMF is for motors and capacitors.



Figure 14: Fuse according to DIN Standards

Standards

- IEC 60470 for the contactor
- IEC 60282-1 for the fuses

Electrical characteristics

		VSC7/P	VSC12/P
Rated voltage	kV	7.2	12
Rated insulation voltage	kV	7.2	12
Rated power frequency withstand voltage	kV 1min	20 ⁽³⁾	28 ⁽³⁾
Rated lightning impulse withstand voltage	kV	60	75
Rated frequency	Hz	50/60	50/60
Rated short-time withstand current	kA ⁽¹⁾	...50	...50
Peak current	kA	...125	...125
Internal arc withstand current ⁽²⁾	kA 1s	...50	...50
Maximum rated current of the contactor	A	400	400

(1) Limited by the fuses.

(2) The internal arc withstand values are guaranteed in the compartments on the supply side of the fuses (busbars and apparatus) by the structure of the switchgear and on the load side (feeder) by the limiting properties of the fuses.

(3) VSC7/PG for 32 kV power frequency withstand voltage and VSC12/PG for 42 kV power frequency withstand voltage are available on request in a dedicated panel.

Maximum performances of the contactor with fuses

		3.6 kV	7.2 kV	12 kV
Motors	kW	1,000	1,800	3,000
Transformers	kVA	2,000	2,500	2,500
Capacitors	kVAR	1,000	1,800	3,000

Maximum load currents of the fuses

Feeder		Transformers		Motors		Capacitors	
Rated voltage	Fuse	Maximum load	Fuse	Maximum load	Fuse	Maximum load	
3.6 kV	200A	160A	315A	250A	450A	360A	
7.2 kV	200A	160A	315A	250A	355A	285A	
12 kV	200A	160A	200A	160A	200A	160A	

1. UniGear ZS1 Switch-disconnector

The UniGear panels can be fitted with ABB NAL type switch-disconnectors.

These units are used to switch and protect feeders and transformers or the auxiliary services transformers in sub and power station.

The NAL switch-disconnectors are medium voltage air-insulated apparatus consisting of a fixed support to which the post insulators are applied (top and bottom), the system of contacts (fixed and moving) and latching pliers (of the fuses or of the insulating bars).

NAL-NALF switch-disconnector

The switch-disconnector is fitted with two systems of moving blade contacts, the main one (through which the load current passes with the switch in the closed position) and the arc-breaking one (through which the current passes during the opening and closing operations).

This solution means the main contacts are not stressed and therefore keeps the electrical characteristics of the apparatus unchanged.

During switch-disconnector opening air is compressed by the pistons contained in the top insulator cylinders. At the moment of opening and separation of the contacts, a blast of compressed air is emitted through special nozzles, so the arc is cooled and deionised.

This leads to a gradual increase in the arc resistance which causes its extinction. The movement of the pistons is synchronised with the arc-breaking contacts of the switch-disconnector -this guarantees the highest inflow of air at the moment of separation of the contacts and there by ensures reliable arc extinction.

The unit can be fitted with insulating bars (NAL switch-disconnector unit) or with medium voltage fuses (NALFswitch-disconnector unit with fuses).

The NALF switch-disconnector is fitted with an automatic release mechanism for fuse tripping and uses fuses in accordance with DIN 43625 Standards. The ABB range of fuses for transformer protection is CEF. Each unit is fitted with an earthing switch with making capacity for earthing the cables.

Switch-disconnector control, like that of the earthing switch, is carried out manually from the switchgear front panel.

The position of both items of apparatus can be seen directly from the front of the switchgear through an inspection window.

The switchgear panel can be fitted with a set of three current transformers or with measurement sensors.

The Disconnecter Feeder unit (DF) consists of two power compartments: busbars and switch-disconnector/cables.

The latter contains both the switch-disconnector and the connection terminals of the power cables.

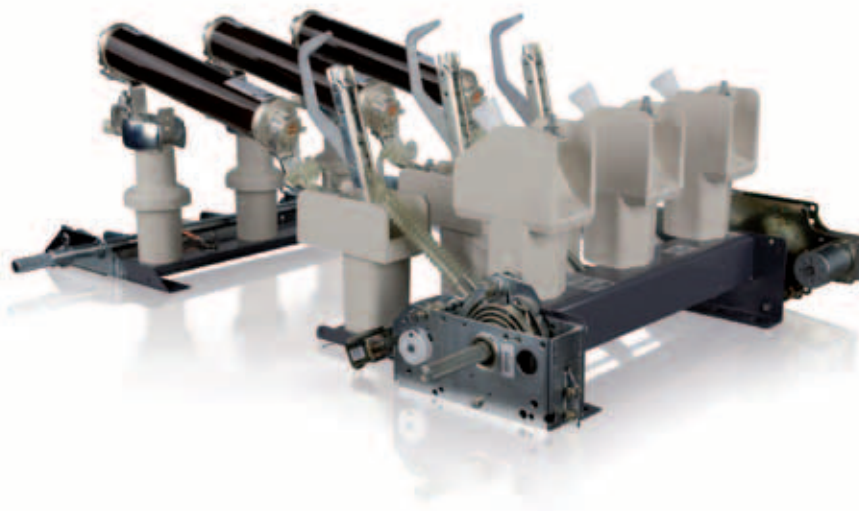


Figure 15: NALF switch-disconnector

Segregation between the power compartments takes place automatically with earthing switch closure. An insulating shutter creates complete separation between the fixed contacts of the switch-disconnector, making the top ones inaccessible to the operators. This makes maintenance operations on the cables and fuses possible, keeping the remainder of the switchgear in operation.

UniGear ZS1 panel with fixed switch-disconnector is classified LSC-2A because the cable and apparatus compartments are not physically segregated.

The switch-disconnector, earthing switch and access door to the cables compartment are interlocked with each other

to guarantee maximum safety for the personnel and correct operation.

Each switchgear panel is fitted with an auxiliary compartment, where the instruments and auxiliary cabling are housed.

All the switchgear panels are accessible from the front and maintenance and service operations can therefore be carried out even when the switchgear is wall-mounted.

Standards

- IEC 60265-1 for the switch-disconnector
- IEC 60282-1 for the fuses

Electrical characteristics

Rated voltage	kV	12	17.5	24
Rated insulation voltage	kV	12	17.5	24
Rated power frequency withstand voltage (1)	kV 1 min	28	38	50
Rated lightning impulse withstand voltage	kV	75	95	125
Rated frequency	Hz	50/60	50/60	50/60

(1) GB/DL version is available with higher request in dielectric characteristics.

NALF switch-disconnector unit with fuses

Rated short-time withstand current	kA (1)	...25	...25	...20
Peak current	kA	...100	...100	...63
Maximum rated current of the fuses	A	100	63	63
Internal arc withstand current (2)	kA 1 s	...40	...40	...25

(1) Limited by the fuses.

(2) The internal arc withstand values are guaranteed in the compartment on the supply side of the fuses (busbars) by the structure of the switchgear and on the load side (cables) by the limiting properties of the fuses.

Selection table of the fuses for protection transformers

Transformer rated voltage [kV]	Transformer rated output (kVA)																Fuse rated voltage [kV]	
	25	50	75	100	125	160	200	250	315	400	500	630	800	1000	1250	1600		2000
CEF Fuse-link In [A]																		
3	16	25	25	40	40	50	63	80	100	125								3.6/7.2
5	10	16	25	25	25	40	40	50	63	80	100	125						
6	6	16	16	25	25	25	40	40	50	63	80	100	125					
10	6	10	16	16	16	20	20	25	31.5	40	50	63	80	100	125			12
12	6	6	10	16	16	16	20	20	25	40	40	50	63	80	100	125		17.5
15	6	6	10	10	16	16	16	20	20	25	40	40	50	63	80	100	125	24
20	6	6	6	10	10	16	16	16	20	20	25	31.5	40	50	63	80		24
24	6	6	6	6	10	10	16	16	16	20	20	25	40	40	50	63	80	

The table was calculated according to standards IEC 60787 and IEC 62271-105 (for operating voltages up to 24 kV). The following transformer work conditions were assumed:

- Maximum long-lasting overload – 150%
- Magnetizing inrush current – 12xIn during 100 ms
- Transformer short-circuit voltage according to IEC 60076-5
- Standard ambient working conditions of fuses

The table above details the rated current of a particular fuse link for a given line voltage and transformer rating. For different criteria, the fuse selection must be recalculated.

The given limits of the rated current of fuse are not mandatory for use in the NALF disconnector / NAL without fuse tripping system. Rated current values of the corresponding fuses for these applications are given in the ABB catalogue "FUSES".

1. UniGear ZS1 Service trucks

The UniGear ZS1 range is equipped with all the service trucks needed for service maintenance activities.

The trucks are divided into four different types:

- Earthing without making capacity
- Earthing with making capacity
- Cable test
- Isolation

Earthing truck without making capacity

These trucks carry out the same function as the earthing switches without making capacity.

They therefore have no capacity to earth live circuits in fault conditions.

They are used to ensure an additional fixed earth, as is required by certain installation service and maintenance procedures, as a further safety guarantee for personnel.

The use of these trucks require the removal of the apparatus (circuit-breaker or contactor) from the switchgear and its replacement with the truck.

The switchgear panels preset for use of the earthing trucks must be provided with a key lock which, when activated, prevents their racking-in.

This truck is available in two versions:

- Earthing of the main busbar system.
- Earthing of the power cables.

The earthing truck of the main busbars, during the racking-in phase, only lifts the top shutter and earths the contacts connected to the top branch connections (and therefore to the main busbar system) by means of the switchgear structure.

The earthing truck of the power cables, during the racking-in phase, only activates the bottom shutter and earths the contacts connected to the bottom branch connections (and therefore to the power cables) by means of the switchgear structure.

These trucks can also be used in the bus-tie unit. In this case, they earth one of the two sides of the main busbar system.

Earthing truck with making capacity

These trucks carry out the same function as the earthing switches with making capacity.

They consist of circuit-breakers provided with top (earthing of the main busbars) or bottom (earthing of the power cables) terminals only. The contacts without terminals are short-circuited by means of a copper bar and connected to earth by means of the apparatus truck.

They keep all the characteristics of the circuit-breakers, such as full making and breaking capacity on live circuits under fault conditions.

They are used to ensure extremely effective earthing on circuits stressed by a fault. They allow opening and closing operations to be carried out rapidly with electric remote control.

The use of these trucks require the removal of the apparatus (circuit-breaker or contactor) from the switchgear and its replacement with the truck.

The switchgear panels preset for use of the earthing trucks must be provided with a key lock which, when activated, prevents their being racked-in.

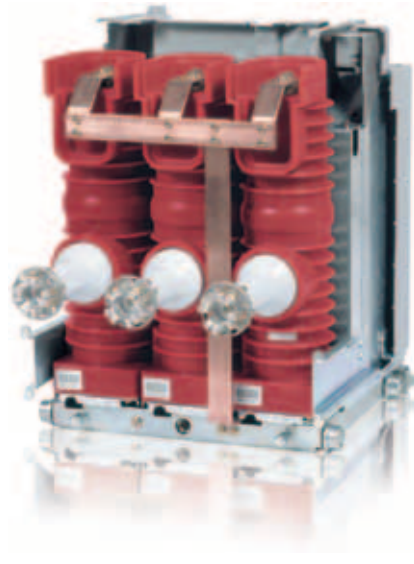


Figure 16: HD4 service truck

This truck is available in two versions:

- Earthing of the main busbar system.
- Earthing of the power cables.

The earthing truck of the main busbars, during the racking-in phase, only lifts the top shutter and presets the contacts connected to the top branch connections (and therefore to the main busbar system) for closing to earth by means of operating mechanism.

The earthing truck of the power cables, during the racking-in phase, only activates the bottom shutter and presets the contacts connected to the bottom branch connections (and therefore to the power cables) for closing to earth by means of operating mechanism.

These trucks can also be used in the bus-tie unit. In this case, they earth one of the two sides of the main busbar system.

Power cable test truck

These trucks allow the insulation tests on the power cables to be carried out without accessing the feeder compartment or disconnecting the cables from the switchgear.

The use of these trucks require the removal of the apparatus (circuit-breaker or contactor) from the switchgear and its replacement with the truck.

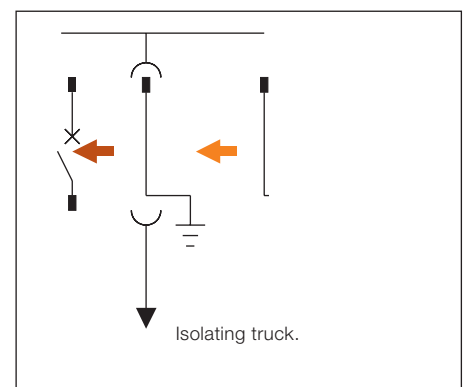
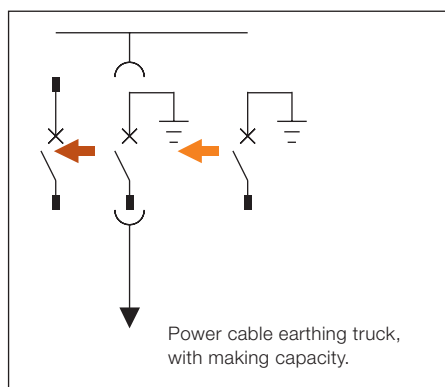
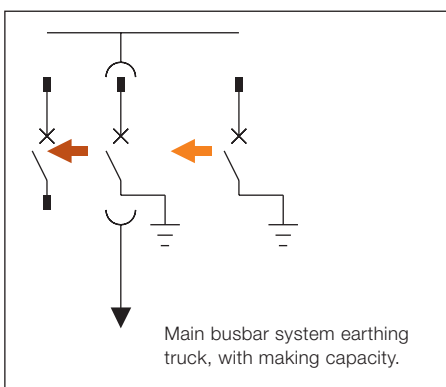
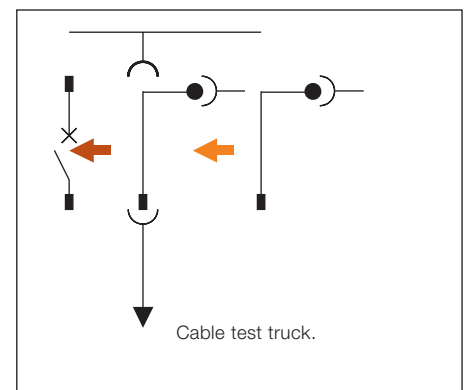
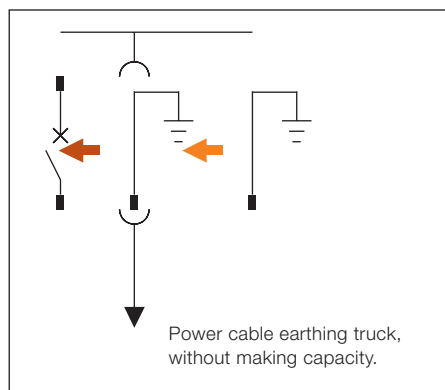
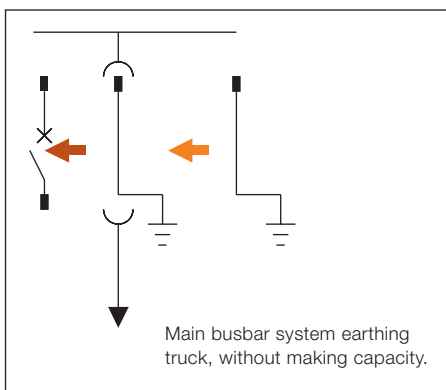
The truck, during the racking-in phase, only activates the bottom shutter and, by means of the connectors it is fitted with, allows connection of the test apparatus cables.

This truck can only be used in the incoming/outgoing feeders with the door open.

Isolating truck

The isolating truck allows the top switchgear contacts to be connected directly to the bottom ones. Connection is made extremely safe by using the poles of the circuit-breakers to insulate the connection busbars from the external environment. In the incoming/outgoing feeder units it connects the main busbar system to the power cables, whereas in the bus-tie, to the two sides of the busbar system. This truck has its application in UniGear switchgear for making incoming/outgoing feeders without a circuit-breaker in radial networks, for making cable connections between two items of switchgear placed in front of each other, in making interconnection units and in creating the bus-tie riser configuration with double insulation (in this case, both the units are made up of bus-ties, the former fitted with a circuit-breaker and the latter with an isolating truck).

The switchgear panels preset for use of the isolating trucks must be fitted with a key lock which, when activated, prevents their being racked-in.



1. UniGear ZS1 Ultra Fast Earthing Switch

The UFES (Ultra Fast Earthing Switch) is an innovative design of an extremely fast-acting earthing switch, grounding all 3 phases within less than 4 ms after detection of an internal arc fault.

The extremely short operating time of the primary switching element, in conjunction with rapid and reliable detection of fault current and light, ensures that an internal arc fault is extinguished nearly immediately after its formation. Thermal and mechanical damage inside of the protected switchgear system are thus effectively prevented.

The UFES is available to fulfil a variety of applications in the UniGear ZS1 switchgear:

- Busbar installation with top-housing box
- Cable compartment installation (12/17.5 kV 50 kA version)

Unbeatable advantages in case of an arc fault event

- Drastic reduction of repair costs: no damages on the switchgear equipment to be expected. No exchange of the faulty panel.
- Greatly increased system availability: after inspection and elimination of the fault reason the switchgear can be taken into service again within shortest possible time.
- Greatly increased operator safety for human mal-operation under maintenance conditions.



Figure 17: Electronic device for measurement, logic and tripping, type QRU1

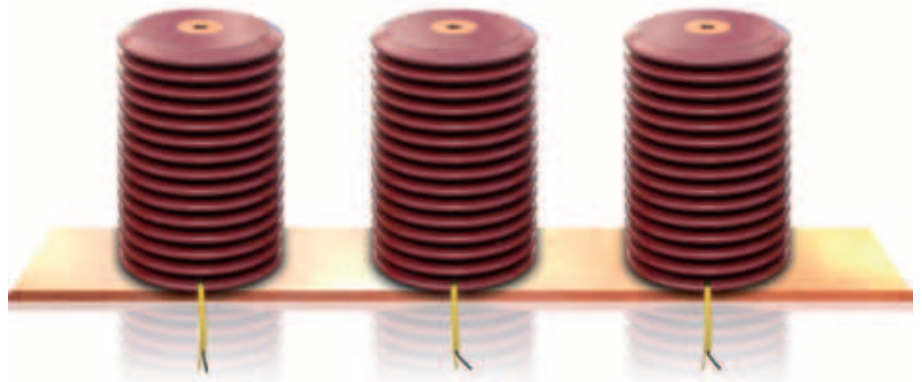


Figure 18: Primary switching element type U1

Electrical maximum characteristics in UniGear ZS1	IEC			
Rated insulation voltage (rms) (1)	kV	12	17.5	24
Rated power frequency withstand voltage (rms)	kV	28	38	50
Rated lightning impulse withstand voltage (peak)	kV	75	95	125
Rated frequency	Hz	50/60	50/60	50/60
Rated short-time withstand current (rms) (1)	kA	50	50	31.5
Rated short-circuit making current	kA	125	125	80
Rated duration of short-circuit	s	3	3	3

(1) GB/DL version is available with higher request in dielectric characteristics (42 kV) and short-time withstand current (4 s).

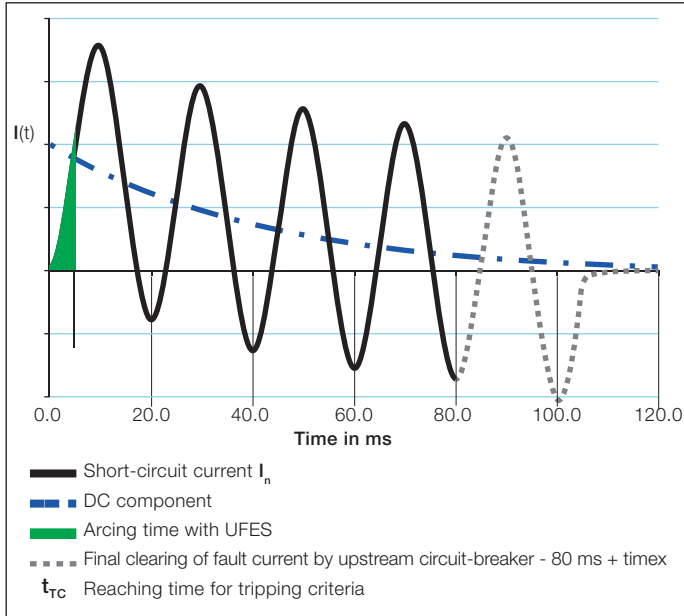


Figure 19: In rare cases, failure inside a switchgear cubicle due either to a defect, an exceptional service condition or mainly by human mal-operation may initiate an internal arc. The faster the arc will be interrupted, the less destruction on the switchgear equipment will occur.

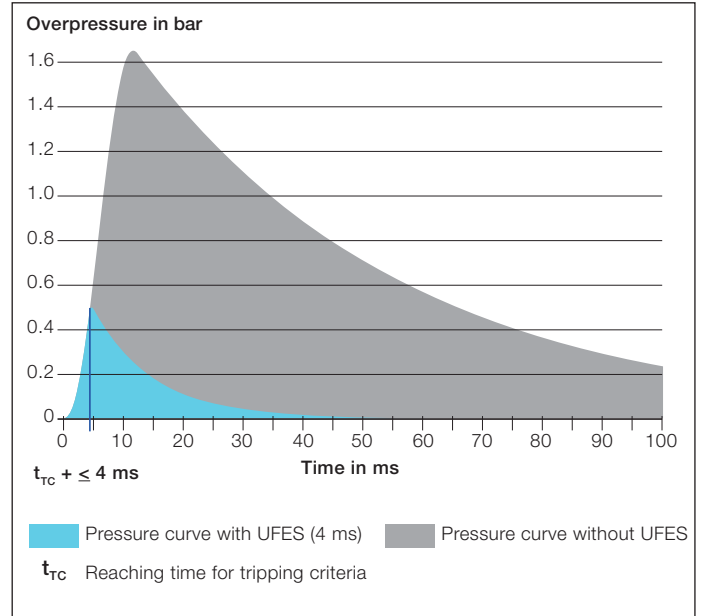


Figure 20: Avoidance of the severe effects of an internal arc fault, such as ...
 - Rapid temperature rise (up to 20,000 °C)
 - Rapid pressure rise (see figure)
 - Burning of materials
 ... by fastest possible extinction.

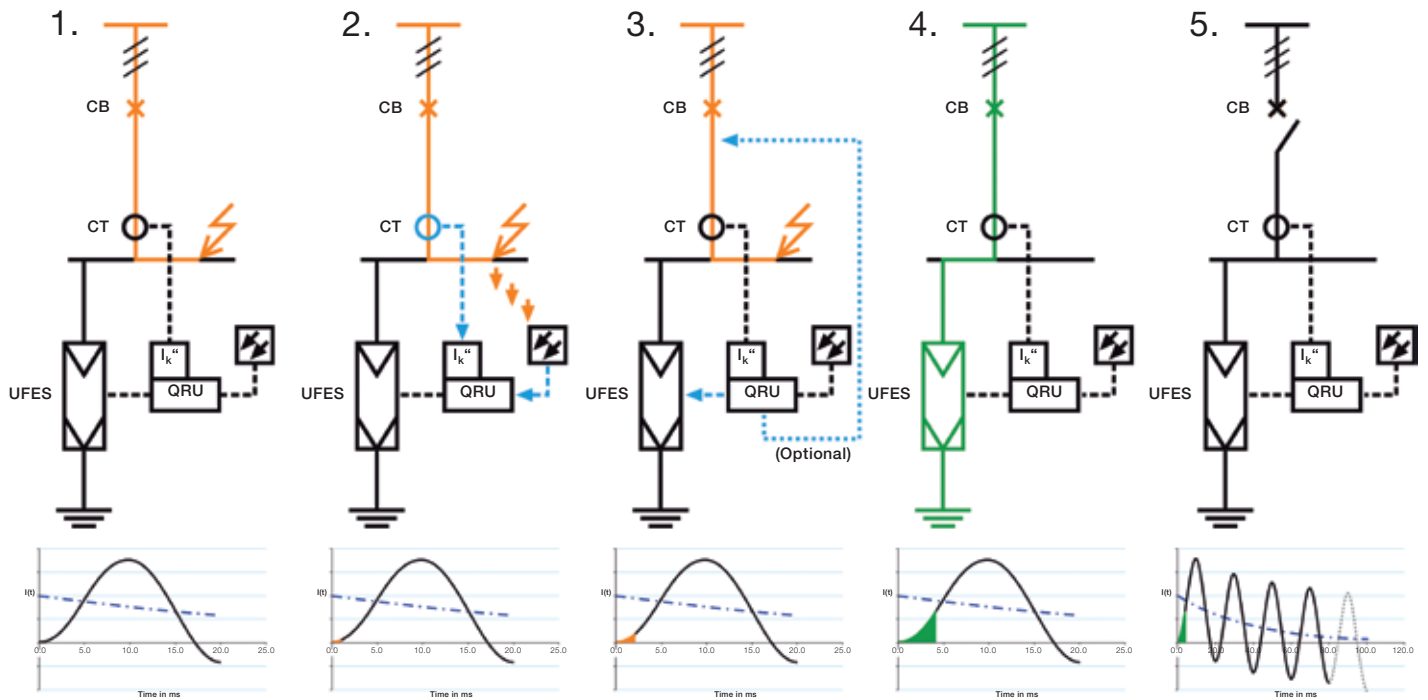


Figure 21: Event sequence description

1. Internal arc formation.
2. Arc detection by the electronic device (light and current).
3. ~ 1-2 ms after detection: Tripping signal to the UFES primary switching elements
4. ~ 3-4 ms after detection: Bolted 3-phase earthing by operation of the UFES primary switching elements.
 → Interruption of the arc voltage: Immediate extinction of the arc.
 → Controlled fault current flow via UFES primary switching elements to earth potential.
5. Final clearing of the fault current by the upstream circuit-breaker.

1. UniGear ZS1

I_s -limiter: fault-current limitation

Short-circuit currents too high?

The I_s -limiter, a switching device with extremely short operating time, solves the problem.

The rising global demand for energy requires more powerful or additional transformers and generators, and an increasing interconnection of the individual supply networks.

This can lead to the permissible short-circuit currents for the equipment being exceeded causing severe dynamic or thermal damage or even complete destruction.

The replacement of existing switchgear and cable connections by new equipment with a higher short-circuit strength is often technically impossible or uneconomical for the user.

The use of I_s -limiters reduces the short-circuit current in both new systems and expansions of existing systems, thus saving cost.

A short-circuit downstream from an outgoing feeder breaker is assumed. The oscillogram shown below indicates the course of the short-circuit currents in the first half wave.

A short-circuit current of 31.5 kA can flow to the fault location through each transformer. This would result in a total short-circuit current of 63 kA, which is twice as much as the switchgear capability.

The course of the current through the I_s limiter in such an event is shown below as current i_2 .

It can be seen that the I_s -limiter operates so rapidly, that there is no contribution via the transformer T2 to the total peak short-circuit current ($i_1 + i_2$). Therefore, a switchgear with a rating of 31.5 kA is suitable for this application.

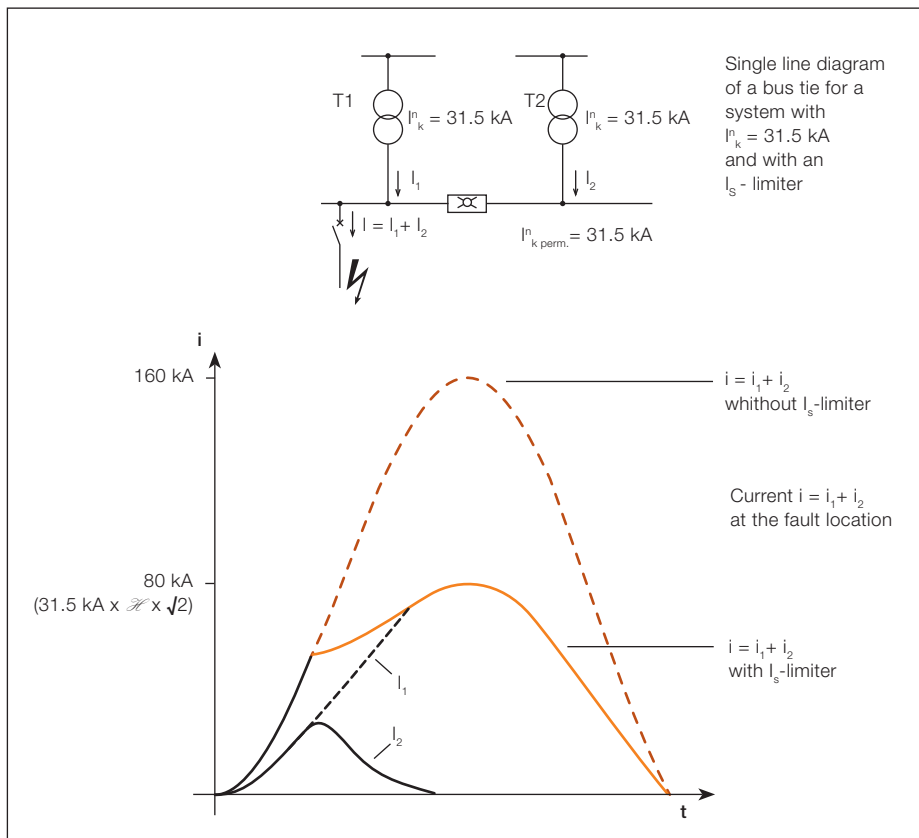


Figure 22: I_s -limiter application diagram



Figure 23: I_s -limiter

Technical Data

Rated voltage	kV	12.0	17.5	24.0	36.0/40.5
Rated current	A	1250/2000/2500/ 3000/4000 ¹⁾	1250/2000/2500/ 3000/4000 ¹⁾	1250/1600/2000/ 2500 ¹⁾ /3000 ¹⁾	1250/2000/2500 ¹⁾
Interrupting current	kA _{RMS}	Up to 210	Up to 210	Up to 140	Up to 140

1) with cooling fan

Potential applications

Such a fast switching device caters for a variety of applications which cannot be fulfilled by conventional switches. The most important of these are presented below.

Advantages of all I_s -limiter applications:

- Reduction of short-circuit currents at the fault location
- No upgrading of the existing switchgear.

Option A, figure 24

Coupling-parallel operation of two systems.

Advantages:

- Improving power quality
- Increasing the reliability of the system
- Reduction of the network-impedance
- Optimal load flow

Option B, figure 24

I_s -limiter in the generator feeder to protect the high voltage system.

Advantages:

- Generator can be connected independent of the short-circuit capability of the system
- Existing busbar system does not need to be changed
- No need for expensive generator breaker

Option C, figure 24

I_s -limiter and reactor connected in parallel.

Advantages:

- Avoid copper losses of the reactor
- Avoid voltage drop over the reactor
- No electro-magnetic field of the reactor

Option D, figure 25

Station service supply and public network.

Advantages:

- Private/industrial generator feeder can be connected to the (fully loaded) grid
- Selective tripping of the I_s -limiter (I_s -limiter will operate only for short-circuit faults in the grid)

Option E, figure 26

If in the case of two I_s -limiters being installed in a switch-board selective tripping is required, a measurement of the total current becomes necessary.

Advantage: The I_s -limiter trips as follows:

- Short-circuit in section A: Only I_s -limiter no. 1 trips.
- Short-circuit in section B: I_s -limiter no. 1 and no. 2 trip.
- Short-circuit in section C: Only I_s -limiter no. 2 trips.

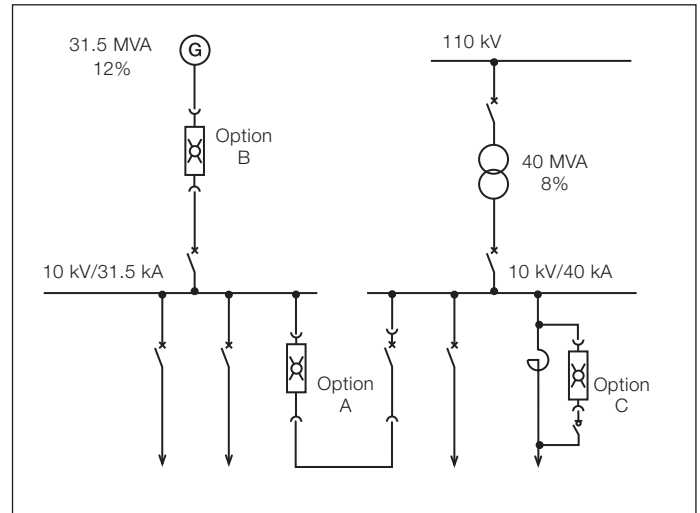


Figure 24: Three possible applications of I_s -limiters in one figure (Option A, B, C)

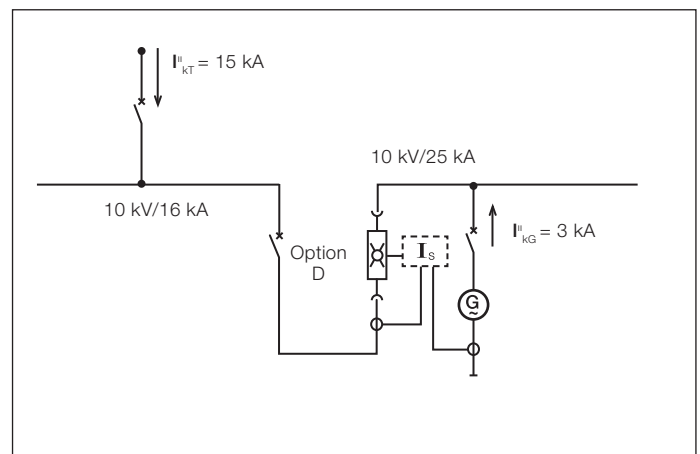


Figure 25: I_s -limiter in connecting point with a public supply network (Option D)

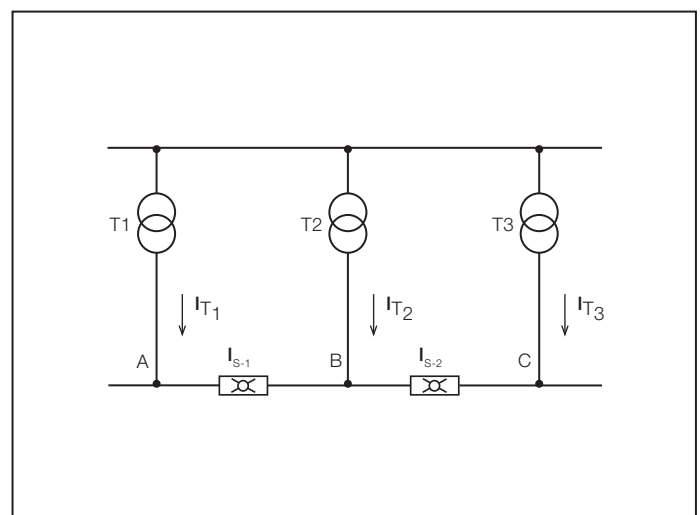


Figure 26: Use of more than one I_s -limiter with selectivity (Option E)

1. UniGear ZS1 Instrument transformers

Block type current transformers

The block type current transformers are epoxy resin insulated and used to supply the measurement devices and protection instruments. These transformers can have a wound core or a bushing bar with one or more cores, with performance and accuracy classes suitable for the installation requirements. They conform to the IEC 60044-1 Standards.

Their dimensions are in accordance with the DIN 42600 Narrow Type Standard, in the Medium and Long Size versions up to 2500 A, where they are of the toroidal type in the range of currents from 3150 A to 4000 A (KOKS type). The current transformers can also be provided with a capacitive socket for connection to voltage signalling devices. The current transformers are normally fitted on the load side of the apparatus compartment for measurement of the phase currents of the switchgear unit. Fitting on the supply side of the apparatus compartment is also possible (busbar applications) for measuring the busbar currents or for realising particular protection schemes. The ABB range of current transformers is designated TPU.

Ring core current transformers

The toroidal transformers are of the epoxy resin insulated type and are used to supply measurement and protection devices. These transformers can feature either a closed or openable core.

They can be used both for measuring phase currents or for detecting the earth fault current. They conform with the IEC 60044-1 Standards.



Figure 27: Toroidal current transformer

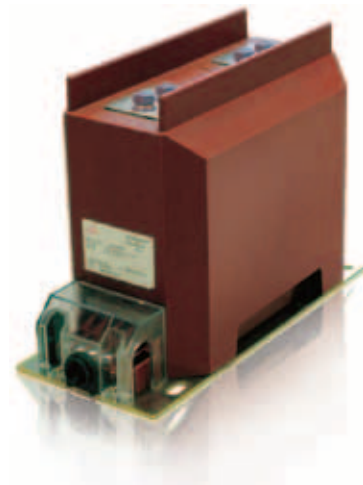


Figure 28: TPU 1250 A



Figure 29: TPU 2500 A



Figure 30: KOKS 3150 A

Voltage transformers

The voltage transformers are of the epoxy resin insulated type and are used to supply measurement and protection devices. They are available for fixed assembly or for installation on removable and withdrawable trucks.

They conform with the IEC 60044-2 Standards.

Their dimensions are in accordance with the DIN 42600 Narrow type Standard.

These transformers can have one or two poles, with performance and precision classes suited to the functional requirements of the instruments connected to them. When they are installed on removable or withdrawable trucks they are fitted with medium voltage protection fuses. The withdrawable trucks also allow replacement of the fuses with the switchgear in service. Truck racking-out with the door closed automatically operates closure of a metallic segregation shutter between the live parts of the switchgear and the instrument compartment.

Fixed voltage transformers can be installed directly on the main busbar system in a dedicated compartment (busbar applications).

The ABB range of voltage transformers is designated TJC, TDC, TJP.



Figure 31: VT truck with fuses



Figure 32: Single pole VTs - type TJC



Figure 33: Double-pole VTs - type TDC

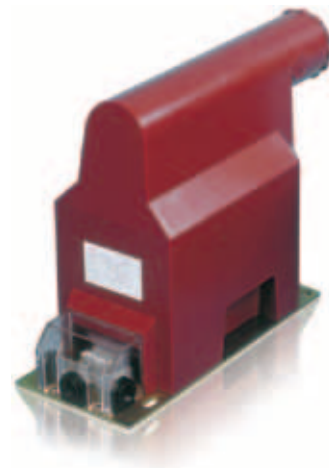


Figure 34: Single-pole VTs with fuse - type TJP

1. UniGear ZS1 Measurement sensors

Electronic instrument transformers

Future for measuring currents and voltages in intelligent UniGear is a low-power instrument transformer (according to present IEC standards they belong to the group of Electronic instrument transformers) called a “sensor” for short. These products replace conventional instrument transformers of both block and ring core types.

The characteristic feature of advanced ABB sensors is the level of output signal, which is fully adapted to fit new microprocessor-based equipment without the need of having unnecessary power.

The analogue output signal level depends on the principle used and can be:

- In the range of mV for current sensor (typical value is 150 mV at rated primary current).
- In the range of volts for voltage sensors where the division ratio is 1:10000 (e.g. output $1/\sqrt{3}$ V for 10 000/ $\sqrt{3}$ kV nominal system voltage at primary/input side).

The UniGear ZS1 can be fitted with KEVCD block type sensor

- KEVCD is block type sensor with shape that conforms to DIN size standard. Two versions could be selected: one providing current measurement together with voltage indication capability or second one, providing, in addition to these, also voltage measurement possibility. All measurements/sensings for each phase is realized within a single body, so there is no need for additional devices.

Characteristics of the sensors

Construction of current and voltage sensors is done without the use of ferromagnetic core. This fact results in several important benefits for the user and the application:

- sensor behavior is not influenced by non-linearity and width of hysteresis curve; that results in accurate and linear response over a wide dynamic range of measured quantities
- single device/sensor could be used for both protection and for measurement purposes (no need for a separate design/product)
- there are no hysteresis losses, so sensors are having excellent frequency response also at frequencies different from the rated one, thus providing very precise input to protection functions, allowing more precise fault analysis and efficient fault location.
- sensors do not have dangerous states in operation (no problem to keep output short-circuited or left open), resulting in high safety for surrounding devices and personell. The output signal remains very low even in fault situations of the network.
- the use of sensors disable the possibility of related ferroresonance phenomena, thus even more increasing the safety and reliability of the power network; furthermore, there is no need for additional protection equipment, special burden or wiring.

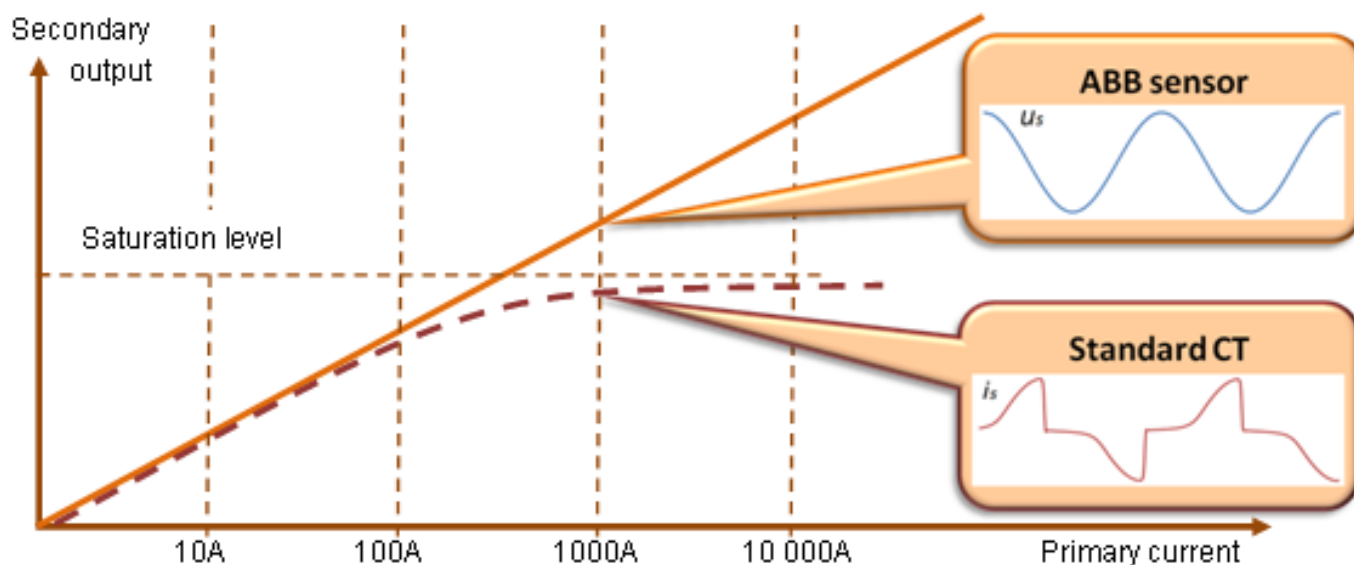


Figure 35: Linearity of advanced ABB sensors and example of output signal waveforms compared to conventional saturated CT

ABB sensors are connected to the measurement and protection evaluation devices by means of shielded cables and connectors, providing a high degree of immunity to electromagnetic disturbances.

Accuracy of these sensors is verified and tested including the cabling, so precise information is assured up to the evaluation device.



Figure 36: KEVCD block type current and voltage sensor

Benefits of the sensors

Due to the linear response and wide dynamic range, sensors are much more standardized devices (compared to a number of different designs of CTs and VTs). Therefore, it is much easier to select the appropriate design (it simplify engineering tasks) and there could be also reduction in spare parts on user side.

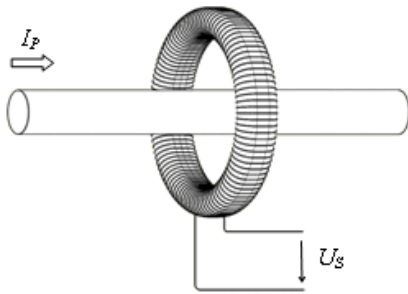
Significantly decreased power consumption during operation of sensors due to negligible losses introduced by sensors (no iron = no hysteresis losses; less winding and negligible output current = small losses in sensor winding) results in huge savings for lost energy and minimized temperature rise (thus improving temperature conditions and ageing within application). It also results in significantly lighter devices, having weight only a fraction of that provided by conventional CTs or VTs. Therefore, no special machines/tools are needed to carry them and transport costs can be smaller.

Fast connection of sensors to IEDs without any tools and material needed simplify and reduce assembly effort.

1. UniGear ZS1 Measurement sensors

Current sensor

The current sensor is based on Rogowski Coil principle. Rogowski Coil work in the same manner as conventional iron-core current transformers (CTs). The main difference between Rogowski Coils and CTs is that Rogowski Coil windings are wound over a non-magnetic core, instead of over an iron core. As a result, Rogowski Coils are linear since the non-magnetic core cannot saturate. Rogowski Coils produce output voltage (U_s) that is a scaled time derivative of the measured primary current (I_p).



$$u_s(t) = M \frac{di_p(t)}{dt}$$

Figure 37: Working principle of Rogowski Coil

Integration of the current sensor output signal is performed within the connected IED in order to obtain the information about actual current value.

In case of purely sinusoidal primary current (I_p) at rated frequency defined as:

$$i_p(t) = \sqrt{2} I_p \sin(\omega t)$$

the output voltage from the Rogowski Coil is

$$u_s(t) = \sqrt{2} I_p M \omega \cos(\omega t)$$

For this case, r.m.s. value of the output signal could be easily measured even without integrator, using a voltmeter or oscilloscope, observing a phase shift of 90° from the primary current waveform.

Output voltage is phase shifted of 90° from the primary current waveform.

Therefore, for simple and rough information about the measured current signal, it is possible to use voltmeters with high input impedance. Nevertheless, more exact and precise information under transient conditions, content of different frequency components or current waveform distortions that appears in electric power network requires integration of voltage signal coming out of Rogowski Coil. This functionality is already available inside of IEDs provided by ABB, so very precise measurement of the primary current is available.

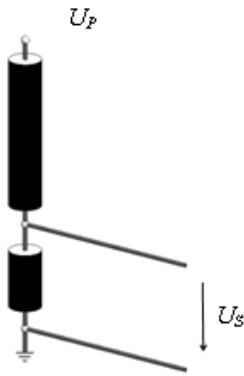
Output voltage of Rogowski Coil linearly depends on frequency, therefore rated value of output voltage is 150mV at 50Hz and 180mV at 60Hz. Once the rated frequency is set in the IED, sensor provides precise information about the measured primary current signal even for different harmonics (no hysteresis losses and no saturation applies) and thus correct performance for all protection functions is assured. In theory, response of Rogowski coil output is linear in unlimited dynamic range of the measured primary current. Constraints in their use originates from other limitations, e.g. application size, fixations etc. Only single coil is sufficient to cover whole range of primary currents needed, e.g. KEVCD sensor type contains a primary conductor and due to this fact just two types are needed to cover the primary current range from 0 to 3200A.

They conform to the IEC 60044-8 standard.

Voltage sensor

The voltage sensor is based on a principle of resistive voltage divider. It consists of 2 resistive elements which divide the input signal to the level that is possible to connect to a standard LV measuring devices.

The main difference between resistive voltage divider and conventional voltage transformer (VT) is their working principle. In case of VTs, voltage is induced in the winding. In case of voltage divider, voltage is simply divided in relation to resistances of the resistive elements thus no induction takes place.



$$U_s = \frac{R_2}{R_1 + R_2} U_p$$

Figure 38: Working principle of resistive voltage divider

Used resistors consists of a rod made of stable ceramic material on which the special non-inductive resistive pattern is applied.

The output signal is a voltage directly proportional to the primary voltage so no integration or any extra processing is needed.

In case of purely sinusoidal primary voltage (U_p) at rated frequency defined as:

$$u_p(t) = \sqrt{2}U_p \sin(\omega t)$$

the output voltage from resistive voltage divider is

$$u_s(t) = \frac{R_2}{R_1 + R_2} \sqrt{2}U_p \sin(\omega t)$$

Also for this case, value of the output signal could be easily measured using a voltmeter or oscilloscope

Standard division ratio used in ABB sensors is 10000/1. This assures the output signal to be sufficient and safe for further processing within IED.

For information about the measured voltage signal, it is possible to use voltmeters with high input impedance, nevertheless the use of ABB IEDs is recommended as this connection has been tested and verified.

Resistive voltage divider has no ferromagnetic core and no winding. Therefore, there is no risk of ferroresonance phenomena as in case of VTs and no additional damping devices are needed for that purpose. The use of such dividers significantly increase safety and reliability of the network as well as enhance safety towards the personnel under all circumstances. There is also no problem or danger in case the secondary terminals are short-circuited. Furthermore, the sensor can remain connected even during switchgear voltage tests at power frequency.

The resistive divider correctly operates even during transients where DC as well as other frequency components are present (no ferromagnetic core inside of the divider means no possibility for saturation at different frequencies). This enable undistorted evaluation of transients and precise analysis of protection functions. Apart from the possibility to measure DC components during transients, resistive voltage divider enables also precise continuous DC voltage measurement at steady-state.

Due to linear response and no possibility of saturation a single divider is sufficient to cover the range of voltages from 0 to 24kV. Nevertheless, in case of overall voltage sensor body, other mechanical requirements or dimensions/distances for different voltage levels may need to be taken into account. For that case, two different heights of KEVCD sensor are available, fitting to standard DIN dimensions. Selected sensor version could then be used also for voltage levels lower then maximum rated primary voltage.

They conform to the IEC 60044-7 Standards.

1. UniGear ZS1

Cable terminations

Terminations for polymer insulated cables 1 – 24 kV

It is crucial that power cables connecting the switchgear are terminated properly, and for this purpose, ABB has developed an excellent range of easy-to-use products for preparation and termination of cables.

MV power cables are normally designed with a conductor of aluminium or copper, an insulation of polymer material, an extruded insulation screen, a metallic screen, armouring (optional) and a polymeric outer jacket.

To enable safe and reliable current carrying properties, it is necessary to achieve sufficient mechanical connection between the cable conductor and the bus bar. ABB offers mechanical cable lugs designed to fit the cable conductor by bolting. It is also essential to guide the electrical field of the cable correctly, and ABB offers Cold Applied terminations, made of rubber, that create an active pressure around the cable. Furthermore, if the cable is designed with another type of metallic screen than copper wires, special earthing kits must be used to achieve proper handling of possible fault currents. The armouring of the cable must have the same earth potential as the cable screen, so it might be necessary to use additional connection accessories that are also available. Detailed information can be found in separate technical information for cable accessories.

Applications and features

Depending on the cable design, it is necessary to use the correct type of cable accessory. When single core cables are designed with copper wire screen only, it is sufficient to use just a cable lug and a termination that fits the actual size of the cable.

The benefit of Cold Applied accessories is that no heat or open flame is necessary for installation (except for branch seals on 3-core cables). After the cable is prepared, the termination is simply slid on without any tools. If a three core cable is used, or a cable with copper tape screen, or aluminium foil screen, or a cable with armouring; then additional material is required.

Another very important factor is correct cable preparation, and ABB also offers excellent cable preparation tools.

Recommended cable termination products

The pre-moulded cable termination type Kabeldon SOT can be used on any polymer cable irrespective of design or conductor size. Type SOT 10 is designed for 7.2 kV cables, while type SOT 24 covers 12, 17.5 and 24 kV. A few variants of terminations fit a wide range of cable sizes. Extra material such as earthing kits, crutch seals for 3-core cables and screen potential material for cable armouring is also covered by the ABB range of products. Please contact your ABB Sales Representative for more information.



Figure 39: ABB Kabeldon cable termination type SOT 10 with bi-metallic cable lug type SKSB



Figure 40: ABB Kabeldon cable termination type SOT 24 with bi-metallic cable lug type SKSB

Designation and sizes

Voltage level kV	Designation Kabeldon	Diameter over insulation mm	Conductor size mm ²			
			7.2 kV	12 kV	17.5 kV	24 kV
1 - 7.2	SOT 101	10.5 - 15	10 - 35	-	-	-
1 - 7.2	SOT 102	12.9 - 25.8	50 - 150	-	-	-
1 - 7.2	SOT 103	21.4 - 34.9	185 - 300	-	-	-
12 - 17.5	SOT 241 A	11 - 15	-	10 - 35	-	-
12 - 17.5	SOT 241	15 - 28	-	50 - 185	50 - 150	-
12 - 17.5	SOT 242	24 - 39	-	240 - 500	185 - 300	-
24	-	-	-	-	-	-
12 - 17.5	SOT 242 B	38 - 54	-	630 (**)	630 (**)	-
24	SOT 241 A	11 - 15	-	-	-	10
24	SOT 241	15 - 28	-	-	-	25 - 120
24	SOT 242	24 - 39	-	-	-	150 - 400
24	SOT 242 B	38 - 54	-	-	-	500 - 630 (**)

(**) Can be mounted on cables with 800 and 1000 mm² by using silicone rubber tape 2342 as top seal.

1. UniGear ZS1 Distribution automation

ABB's Power Protection Philosophy

With deliveries of protection IEDs (Intelligent Electronic Devices) to more than 70 countries, ABB best understands the requirements of diverse protection needs as a result of wide ranging local legislation, safety requirements and engineering practices. Therefore, ABB has developed a power protection philosophy that not only serves the specific needs and requirements of diverse power systems, but also creates a feeling of confidence and peace of mind for both power system owners and users alike.

The main purpose of an ABB IED power protection system is to recognize any abnormal power system conditions, or abnormally operating components within the power system. Then, based on the information gathered by the IED, the power protection system will initiate corrective actions to

return the power system to its normal operating state, or, isolate the fault to limit damage to the power system and injury to personnel. This provides a safe environment for all. Power protection systems do not prevent power network faults from arising, but it will be activated only when an abnormality has occurred in the power system. However, carefully matching the available protection functionality offered by ABB IEDs to the specific power protection requirements of the power system and its components not only provides the best power protection for the power system, but also improves the performance and the reliability of the power protection system within it, thus minimizing the effects of power network faults and preventing the abnormalities or disturbances from spreading to the healthy parts of the power network.



Advantages of a complete power protection system

Operating speed, sensitivity, selectivity and reliability are the integral elements of the power protection system and need mentioning. There is a strong correlation between the operating speed of the power protection system and the damage and danger caused by a power network fault. Substation automation provides remote control and monitoring capabilities, which speeds up the location of faults, and therefore the restoration of the power supply after a fault. Fast operation of the power protection IEDs also minimizes post-fault load peaks, which together with voltage dips increase the risk of the power disturbance spreading to healthy parts of the power network. The sensitivity of the power protection must be adequate to detect relatively high

resistance earth faults and short circuits in the most distant parts of the power network. Reliable selectivity is essential in order to limit the loss of power supply to as small an area as possible, and to allow the abnormal or faulted part of the power network to be reliably located.

Corrective actions can then be directed to the abnormal or faulty part of the network, and the supply can be restored as rapidly as possible.

The power protection system must also have a high degree of reliability. This also means that if for example a CB (circuit-breaker) fails to operate, the backup power protection will identify the fault and react.

Substation Automation (SA) puts the operator in perfect control of the substation. In addition to the SA system improving the power quality of the power transmission and distribution network under normal operation, it especially improves the quality of the power transmission and distribution network's available power in a situation of disturbance and during substation maintenance. A SA system or SCADA (supervisory control and data acquisition) system brings the full benefits of numerical technology into protection and control of power networks. The terminals are easily set and power protection parameters configured to the specific needs of the power system through easy and safe access via the operator's workplace.

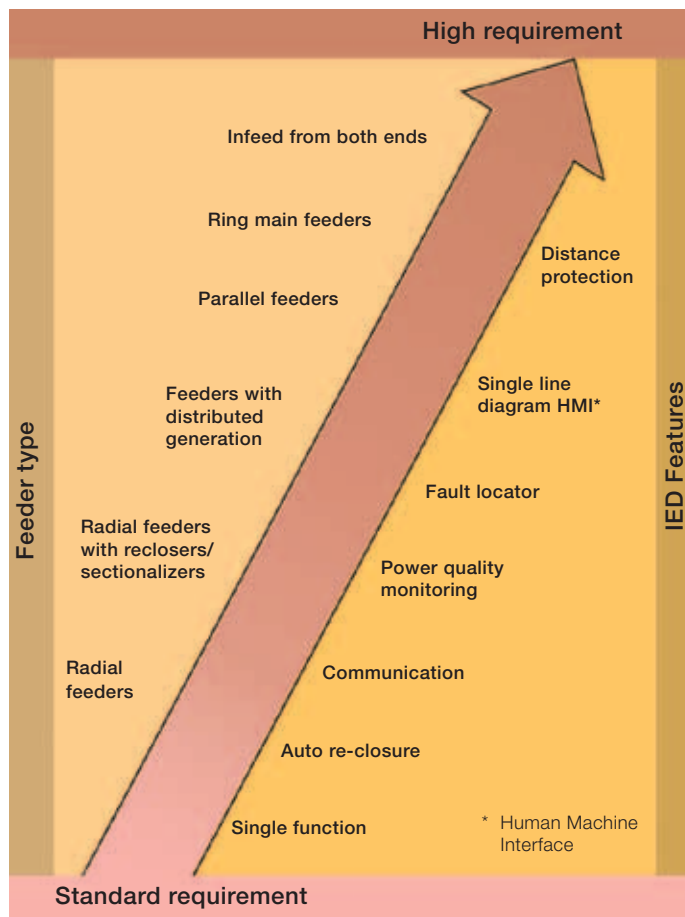


Figure 41: Comparison between standard and high requirement feeders

Single-function and multi-function terminals

Correct power protection methods and comprehensive functionality increase the performance of the power protection system.

The definition of comprehensive functionality varies with the requirements of the protected power network or system. While single-function power protection IEDs are sufficient for some network applications, more complex power networks and systems need advanced multi-functional power protection IEDs. Single-function Power protection IEDs include a set of power protection functions for, for instance, a specific feeder application type.

The main advantages of these power protection IEDs are redundancy and price. One or more single-function power protection IEDs would provide sufficient protection in most power protection application areas.

1. UniGear ZS1

Distribution automation

Feeder protection

The power protection applications can be roughly divided into two categories, namely standard applications (utilizing basic current based protection) and high requirement applications (utilizing current and voltage based protection) and then also the combinations of the two.

The selected power protection scheme or system has to fulfill the application-specific requirements regarding sensitivity, selectivity and operating speed of the power protection.

The power protection requirements are mainly determined by the physical structure of the power network or system and in most cases the requirements can be fulfilled with non-directional/directional over-current protection IEDs.

In power networks or systems with a more complex structure more advanced power protection functions like distance protection or line differential protection may have to be introduced.

The purpose of the over-and under-voltage power protection system is to monitor the voltage level of the network. If the voltage level deviates from the target value by more than the permitted margin for a set time period, the voltage protection system is activated and it initiates actions to limit the duration of this abnormal condition and the resulting stresses caused to the power system or its components.

To prevent major outages due to frequency disturbances, the substations are usually equipped with under-frequency protection IEDs, which in turn control various power load-shedding schemes. These are just a few examples of the major power protection functions for power feeders.

Applications and features

Depending on the requirements a suitable IED type can be selected and configured in such a way that an overall solution can be found for different feeder types.

Generally, the required power protection functionality of these feeder types differ greatly depending on, amongst other things, the characteristics of the source of the fault current and the type of advanced functions that may be additionally needed to fulfill the basic requirements of the power protection application.

Recommended products

The recommended products for feeder protection are part of ABB's Relion® product family of power protection IEDs. These IEDs have been developed after many years of experience gathered from wide ranging application and functionality requirements of ABB customers globally. The popular RE500 series IEDs also played a big part in ABB's success in this area.

Relion® products have been designed to implement the core values of the IEC 61850 standard. The genuine implementation of the IEC 61850 substation communication standard covers vertical as well as horizontal communication between IEDs.



Figure 42: Feeder protection and control REF630

- **Feeder Protection and Control REF630** provides main protection for overhead lines and cable feeders of power distribution networks. REF630 fits both isolated neutral networks and power networks with resistance or impedance earthed neutral. Four pre-defined configurations to match typical feeder protection and control requirements are available. The pre-defined configurations can be used as such, or the IED can easily be modified or functionally extended with freely selectable add-on functions to help fine-tune the IED to meet even the most demanding individual application requirements -exactly.

- **Feeder Protection and Control REF615** is a dedicated feeder IED perfectly aligned for the protection, control, measurement and supervision of utility and industrial power distribution systems. It provides mainly protection for overhead lines, cable feeders and busbar systems of power distribution substations. It fits both isolated neutral networks and power networks with resistance or impedance earthed

neutrals. Furthermore, making use of the IED's advanced inter-station communication facilities, REF615 can also be applied for protection of ring-type and meshed distribution networks as well of radial networks.

As of now, the REF615 suite consists of eight standard configurations to suit the most common feeder protection and control applications as well as your current and forthcoming feeder protection requirements.

- **Feeder Protection REF610** is primarily intended for the protection of incoming and outgoing feeders in power distribution substations of resistance earthed and solidly earthed power systems. REF610 is suitable for employment in marine and off-shore environments. Supplied with an optional arc protection function REF610 also provides fast substation busbar arc-fault protection. The REF610 is also used for back-up protection of motors, transformers and generators to increase protection redundancy in critical utility and industrial applications.



Figure 43: Feeder protection and control REF615



Figure 44: Feeder protection REF610

1. UniGear ZS1 Distribution automation

Transformer protection

The power transformer is one of the most important components, as well as one of the most valuable individual units in the power distribution network. Therefore, the particular importance of preventing disturbances in the power distribution system is almost completely dependent on a functioning power transformer. Although high-quality power transformers are highly reliable, insulation breakdown faults occasionally occur. These faults, appearing as short circuits and/or earth faults generally cause severe damage to the windings and transformer core. The damage is proportional to the fault clearing time so the power transformer must be disconnected as quickly as possible. The power transformer has to be transported to a workshop for repair, which is a very time-consuming process. The operation of a power network where the power transformer is out of service is always cumbersome. Therefore, a power transformer fault often constitutes a more severe power system fault than a line fault, which usually can be rectified rather quickly. It is extremely important that fast and reliable protection IEDs are used to detect transformer faults and initiate tripping. The size, voltage level and importance of the power transformer determine the extent and choice of monitoring and protection devices to be used to limit the damage at a possible fault. When compared to the total cost of the power transformer and the damages caused by a power transformer fault, the cost of the power protection system is negligible.

Recommended products

The recommended products for transformer protection are part of ABB's Relion® product family of power protection IEDs. These IEDs have been developed after many years of experience gathered from wide ranging application and functionality requirements of ABB customers globally. The popular RE500 series IEDs also played a big part in ABB's success in this area. Relion® products have been designed to implement the core values of the IEC 61850 standard. The genuine implementation of the IEC 61850 substation communication standard covers vertical as well as horizontal communication between IEDs.



Figure 45: Transformer protection and control RET630

- **Transformer Protection and Control RET630** is a comprehensive transformer management IED for protection, control, measuring and supervision of power transformers, unit and step-up transformers including power generator-transformer blocks in utility and industry power distribution networks. It provides main protection for two-winding power transformers and power generator-transformer blocks. Two predefined configurations to match your typical transformer protection and control specifications are available. The pre-defined configurations can be used as such, or the IED can easily be modified or functionally extended with freely selectable add-on functions to help fine-tune the IED to meet even the most demanding individual application requirements - exactly.

- **Transformer Protection and Control RET615** is a dedicated transformer protection and control IED for two-winding power transformers, unit and step-up transformers including power generator-transformer blocks in utility and industrial power distribution systems. RET615 offers eight standard configurations to match applied transformer neutral earthing principles with either high impedance or numerical low impedance restricted earth-fault protection schemes. CT ratio differences and phase shifts of all commonly employed power transformer vector groups are numerically compensated for. RET615 features also local or remote control of the transformer HV side circuit_breaker.



Figure 46: Transformer protection and control RET615

1. UniGear ZS1

Distribution automation

Motor protection

Motor protection is generally expected to provide overcurrent, unbalance, earth-fault and short-circuit protection. However, the fundamental issue for motors is thermal protection, as overheating is the worst threat to the motor.

Motors need to be protected not only against electrical faults but also against any improper usage. ABB's solutions focus on advanced thermal protection that prevents improper use of the motors. The thermal overload protection is needed to protect the motor against both short-time and long-time overload and so it is of great importance for the performance of the motor. Overload conditions of short duration mainly occur during motor start-up.

Improper use of a running motor does not necessarily damage the equipment but shortens its lifespan. Therefore, a reliable and versatile motor protection system not only protects the motor but it also prolongs the motor's life-cycle, which contributes to improving the return on investment of your motor drive.

Recommended products

The recommended products for motor protection are part of ABB's Relion® product family of power protection IEDs. These IEDs have been developed after many years of experience gathered from wide ranging application and functionality requirements of ABB customers globally. The popular RE500 series IEDs also played a big part in ABB's success in this area.

Relion® products have been designed to implement the core values of the IEC 61850 standard. The genuine implementation of the IEC 61850 substation communication standard covers vertical as well as horizontal communication between IEDs.

- **Motor Protection and Control REM630** is a comprehensive motor management IED for protection, control, measuring and supervision of medium and large asynchronous motors in medium voltage industrial power systems. REM630 is a member of ABB's Relion® product family and a part of its 630 product series characterized by functional scalability and flexible configurability. It also features necessary control functions required for the management of industrial motor feeder bays.



Figure 47: Motor protection and control REM630



Figure 48: Motor protection and control REM615

REM630 provides main protection for asynchronous motors and the associated drives. The motor management IED is intended for circuit-breaker and contactor controlled medium sized and large asynchronous motors in a variety of drive applications, such as motor drives for pumps, fans, compressors, mills, crushers, etc. The pre-defined configuration can be used as such or easily customized or extended with add-on functions, by means of which the motor management IED can be fine-tuned to exactly satisfy the specific requirements of your present application.

- **Motor Protection and Control REM615** is a dedicated motor IED perfectly aligned for the protection, control, measurement and supervision of asynchronous motors in manufacturing and process industry. Typically, REM615 is used with circuit-breaker or contactor controlled HV motors, and contactor controlled medium sized and large LV motors in a variety of drives. REM615 is available in three standard configurations including all the basic motor protection functions, voltage protection functions and power and energy measurements. Local or remote start/stop control of the motor is also facilitated.

- **Motor Protection Relay REM610** is a motor IED for the protection, measuring and supervision of medium sized and large asynchronous LV motors and small and medium-sized asynchronous HV motors in manufacturing and process industry.

The REM610 IED can be used with both circuit-breaker and contactor-controlled motor drives in a variety of applications. Enhanced with an optional add-on card for RTD sensors or thermistor elements, the IED can be used for direct temperature measurement of critical motor items, such as bearings and windings. It is also used for the protection of cable feeders and distribution transformers benefiting from thermal overload protection besides phase overcurrent protection, earth-fault protection and phase unbalance protection.



Figure 49: Motor protection REM610

1. UniGear ZS1

Distribution automation

Voltage Protection

REU615 is available in two predefined, off-the-shelf configurations, denoted A and B, targeted for two of the most common applications of the IED.

The A configuration of REU615 is pre-adapted for voltage and frequency based protection applications in utility and industrial power systems and distribution systems including networks with distributed power generation.

The A configuration of REU615 is indented to be used in medium voltage switchgear systems with a separate voltage measuring cubicle.

The A configuration of REU615 provides busbar overvoltage and undervoltage supervision, network residual voltage and frequency supervision.

The B configuration is pre-adapted for automatic voltage regulation. Both configurations also allow CB control and provide measuring and supervising functions. The B configuration of REU615 featuring voltage regulation capability is targeted for automatic and manual voltage regulation of power transformers equipped with a motor driven on-load tap-changer.

REU615 is a member of ABB's Relion® protection and control product family and its 615 product series. The 615 series IEDs are characterized by their compactness and withdrawable-unit design. Re-engineered from the ground up, the new 615 series has been designed to unleash the full potential of the IEC 61850 standard for communication and interoperability between substation automation devices.



Figure 50: Voltage protection REU615

Arc protection

An electric arc short-circuit in a switchgear installation is normally caused by a foreign object entering the cubicle or a component failure. The arc causes an explosion-like heat and pressure effect usually causing vast damage to the switchgear and the operation personnel.

An adequate arc protection system protects your substation against arc faults by minimizing the burning time of the arc, thus preventing excessive heat and damage. It minimizes material damage and allows power distribution to be smoothly and safely restored. The system can also bring cost benefits even before an arc fault occurs. As older switchgear is more prone to arc faults, an arc protection system will effectively extend the life of your switchgear and make more of your investment. But what is even more important, this technology can help save lives.



Figure 51: Arc protection REA 101 with extensions REA 103, REA 105 and REA 107

Applications and features

Sources of arcing may be insulation faults, maloperating devices, defective bus or cable joints, overvoltage, corrosion, pollution, moisture, ferro-resonance (instrument transformers) and even ageing due to electrical stress. Most of these arc fault sources could be prevented by sufficient maintenance. However, in spite of the precautions taken, human errors can lead to arc faults.

Time is critical when it comes to detecting and minimizing the effects of an electric arc. An arc fault lasting 500 ms may cause severe damage to the installation. If the arc lasts for less than 100 ms the damage is often restricted, but if the arc is extinguished in less than, for example, 4 ms the damage is insignificant.

Generally applied, protection IEDs are not fast enough to ensure safe fault clearance times at arc faults.

The operation time of the overcurrent IED controlling the incoming circuit breaker may, for instance, have to be delayed hundreds of milliseconds for selectivity reasons.

This delay can be avoided by installing an arc protection system. The total fault clearance time can be reduced to max 2.5 ms plus the circuit breaker's contact travel time.

Furthermore, at cable compartment faults, auto-reclosures can be eliminated by employing arc protection.

Recommended products

- **Arc protection system REA 101** with its extension units REA 103, REA 105 and REA 107 are designed to be used for the protection of medium and low-voltage air-insulated switchgear.

The central unit type REA 101 operates independently or together with other REA 101 units. REA is the fastest arc protection system on the market, providing tripping times down to 2.5 ms.

REA is equipped with a fast integrated overcurrent-sensing element and is thus working independently from other feeder protection units.

The REF615 and REF610 feeder protection IEDs include an optional arc protection function for the feeder cubicle.

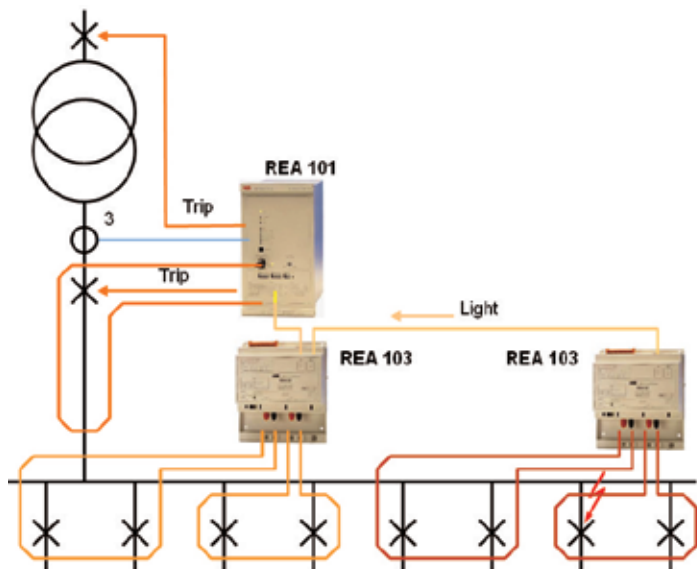


Figure 52: Typical setup with REA 101 and subunits 103

1. UniGear ZS1

Distribution automation

Station automation COM600

COM600, ABB's station automation device, is an all-in-one communication gateway, automation platform and user interface solution for utility and industrial distribution substations.

The gateway functionality provides seamless IEC61850 connectivity between substation IEDs and network-level control and management systems.

The automation platform with its logic processor makes COM600 a flexible implementation platform for substation level automation tasks. As a user interface solution COM600 accommodates web technology based functionalities providing access to substation devices and processes via a web browser based human machine interface (HMI).

Product

The Station Automation COM600 offers web server functionality, providing a human machine interface (HMI) for local substation monitoring and control. Secure communication enables the access of the substation HMI over the internet or LAN/WAN for any authorized user with a standard PC and a web browser. By connecting a laptop computer to the unit locally, an HMI for full monitoring and control functionality is obtained on the substation level.

The Station Automation COM600 also provides gateway functions for mapping data and signals between substation and higher-level systems such as SCADA, DSC.

The COM600 is designed for smooth system integration and interoperability based on pre-configured solutions utilizing connectivity packages for ABB IEDs.



Figure 53: Station Automation COM600

Application and features

With their compact and robust design, the COM600 is well adapted for harsh environments. It meets the IP4x degree of protection by enclosure and contains no moving parts subject to wear and tear. The COM600 is based on embedded technology for durability and maximum availability. The features and compact dimensions of the COM600 enable it to be easily installed in the Low Voltage Compartment of most UniGear ZS1 panels. COM600 is suitable for both industrial and utility applications.

The COM600 incorporates OPC Server functionality, which provides one entry point to all the information of a substation, and the IEC 61850 support enables connectivity and seamless communication with application-specific equipment.

The COM600 is fully compliant with the IEC 61850 standard for distribution automation. Thus it provides full interoperability with any IEC 61850 compliant IEDs, tools and systems, which simplifies system design and commissioning.

The commissioning of ABB IEDs is straight forward due to the support of ABB's unique connectivity package concept, which simplifies system configuration and reduces the risk of errors in the system integration, minimizing device configuration and set-up times.

For more detailed information, the technical and product guides for COM600 are available at

<http://www.abb.com/substationautomation>

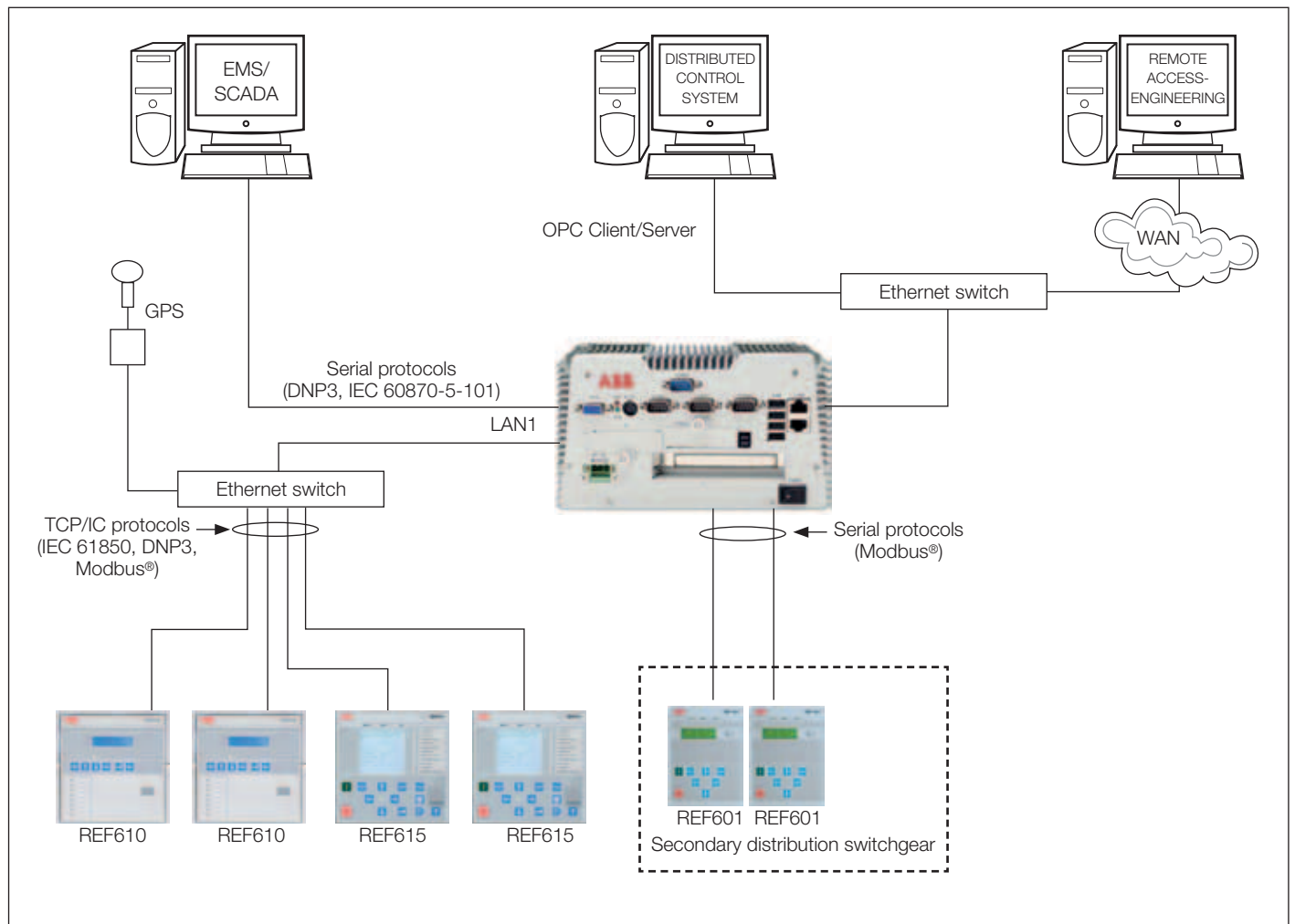


Figure 54: Overview of a system using Station Automation COM600

1. UniGear ZS1

Distribution automation

Selection table of relays

Application	REF					RED	
	610	615	630	54_	542+	615	
Voltage based protection		•		•	•		
Feeder application (Incomming and/or Outgoing)	•	•	•	•	•	•	
High requirement feeder application			•	•	•		
Transformer application				•	•		
High requirement transformer application					•		
Motor protection				•	•		
High requirement motor protection					•		
Generator & synchronous motor protection							
Distance protection			•	•	•		
Line differential protection					•	•	
Back-up Protection	•			•	•		
Arc protection	o	o					
Communication Protocols							
IEC61850-8-1	o	•	•	•*	•*	•	
IEC60870-5-103	•	•		•	•	•	
DNP 3.0	•	•	•	•	•	•	
SPA	•			•	•		
LON				•	•		
Modbus	•	•		•	•	•	
Profibus	o	•*		•*	•*	•*	
Additional Functionality							
Fault locator			•	•	•		
Auto re-closure	3 shots	5 shots	2 shots	5 shots	5 shots	o(5 shots)	
On load tap changer control							
Disturbance recording	•	•		•	•	•	
Withdrawable release mechanism	•	•				•	
Single line diagram HMI**		•	•	•	•	•	
Local control	•	•	•	•	•	•	
Remote control	•	•	•	•	•	•	
Condition monitoring		•	•	•	•	•	
Power quality monitoring				•			
Analog inputs (VT/CT)	-/4		9/8			-/5	
Sensor inputs		•		•	•		
Binary Inputs / Outputs	5/8	18/13	32/27		42/24****	18/13	
RTD*** / mA inputs				8 / -	6		
mA outputs				o(4)	o(4)		

* With interface protocol converter

** HMI - Human Machine Interface

*** RTD - Resistive Temperature Detector

**** 27 if outputs are static outputs

1) REU615 with A configuration, for voltage and frequency based protection

2) REU615 with B configuration, for tap changer control

o = optional

s = secondary application

	REM				RET				REU		REX	REA
	610	615	630	54_	615	630	54_	610	615	521	10_	
				•			•	•	• ¹	•		
s								•		•		
s					•	•	•		• ²	•		
	•	•	•	•			•			•		
			•	•								
			•	•								
		0			0				0		•	
•*	•	•	•	•*	•	•	•*	0	•	•*		
•	•				•		•	•	•	•		
•	•	•			•	•	•	•	•	•		
•*				•			•			•		
•	•			•	•		•	•	•	•		
•*				•	•*		•*	0	•*	•*		
							5 shots			5 shots		
•	•			•	•	•	•	•	• ²	•		
•	•			•	•		•	•	•	•		
•	•	•		•	•	•	•	•	•	•		
•	•	•		•	•	•	•	•	•	•		
				•			•			•		
-/4	-/5	4/5			-/7	3/9		4/-			-/3	
5/8	12/10	32/27			14/13	32/27		5/8			1/3	
6 / -	6/2		8 / -		6 / 2		8 / -		6 / 2 ²			

1. UniGear ZS1 Automatic transfer system

Automatic transfer systems are used to ensure maximum service continuity, supplying the power users uninterruptedly.

All this is possible using various systems based on different kinds of techniques.

The most common of these are outlined below, with the relevant average transfer times:

- Delayed: 1500 ms
- Depending on the residual voltage: 400-1200 ms
- Synchronised (ATS): 200-500 ms
- High speed (HSTS): 30-120 ms

The first two systems are the simplest and can also be achieved with conventional logics and instruments. They guarantee average transfer times and can therefore be used in installations where voltage gaps are not particularly critical.

On the other hand, the other two systems (ATS – Automatic Transfer System and HSTS – High Speed Transfer System) require microprocessor-based apparatus with high technology content.

They guarantee fast transfer times and their application is in plants where the process is particularly critical, so that transfers which are not extremely fast would cause serious malfunctions or interruption of the process itself.

ABB is able to offer all the transfer systems, from the simplest to the most complex.

ATS

The REF542*plus* unit can be used in medium voltage switchgear to manage automatic and manual transfer between two different incoming feeders.

The time needed for automatic transfer carried out by means of the REF542*plus* unit is between 200 and 300 milliseconds (including the circuit-breaker operating times).

This time can vary within the range indicated in relation to the complexity of the software transfer logics.

Switchgear equipped with REF542*plus*, suitably programmed, are complete and efficient systems able to manage transfer between one power supply system and an alternative one, or to reconfigure the network, passing from double radial distribution to a simple system, in a fully automatic way.

It is also possible to carry out the same operation manually from a remote control station, or from the front of the switchgear under user supervision.

Manual transfer means making the passage parallel: by means of the synchronism control function (synchro-check-code 25) implemented from the REF542*plus*, the power supply lines are closed simultaneously with synchronisation of the voltage vectors to then return to being disconnected when transfer has taken place.

The applications described do not require additional instruments.

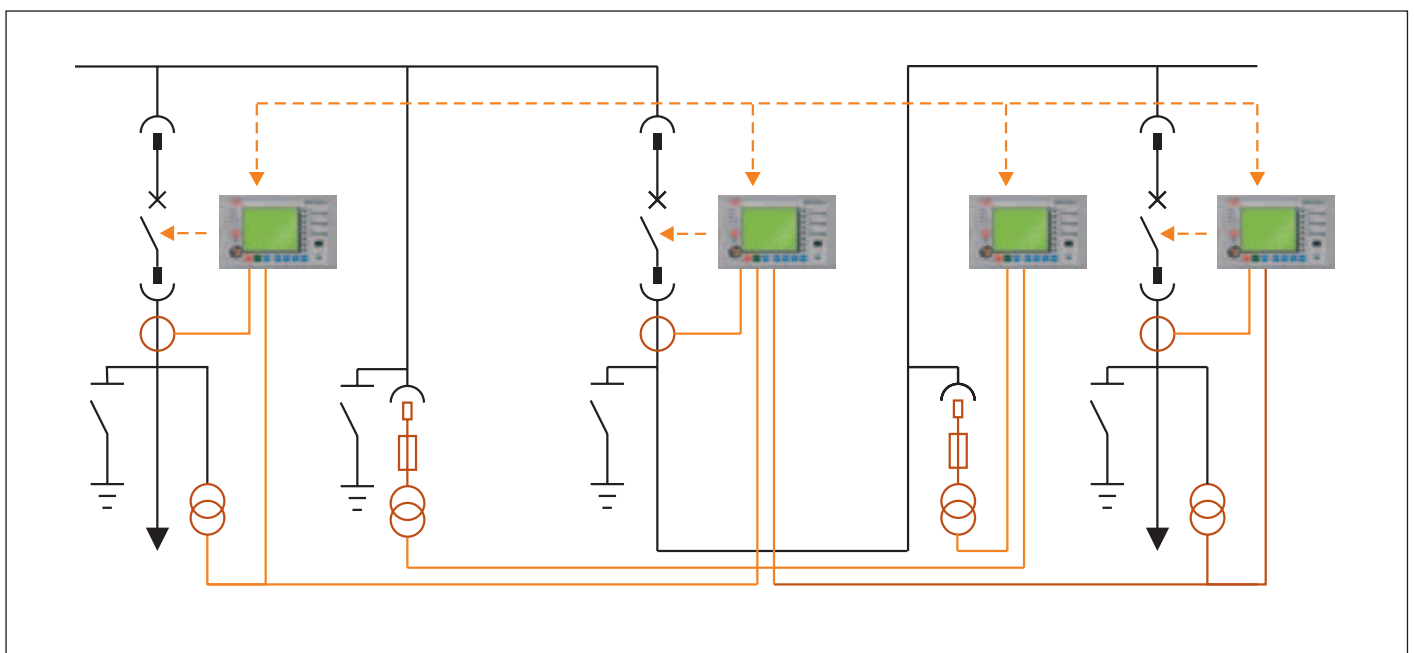


Figure 55: Single-line diagram of UniGear ZS1 switchgear with REF542*plus* architecture applied, suitable for carrying out automatic and manual transfer (ATS), as well as the switchgear protections and measurements

SUE3000 High Speed Transfer Device

Voltage decreases or complete supply interruptions represent the most important and critical problems for the quality of energy supply today. The SUE3000 High Speed Transfer Device guarantees an optimum safeguarding of energy supply. The device ensures the continued supply to the consumer through automatic transferring of power to a stand-by feeder and protects the subsidiary process from expensive stoppage time. Furthermore, through the possibility of manually-initiated power transfers –for targeted clearings, for example –the installation is considerably simplified.

• Application areas

The SUE3000 High Speed Device can be implemented in applications where a disturbance of the electrical power supply would lead to a breakdown in production and the resulting costs or loss in productivity.

Possible areas of utilization include for example:

- Auxiliary installation serving power stations
- Environmental technology installations
- Voltage supply to continuous industrial processes.

In order to realize a permanent availability of power, the load is supplied from at least two synchronized feeders which are independent from one another and which are equipped with SUE3000 High Speed Transfer Devices.

In doing so, the SUE3000 High Speed Transfer Device has the task of ensuring uninterrupted continuous operation of the connected devices in case of a power supply breakdown, taking into account different physical factors; by way of the fastest possible transfer to a standby feeder.

Corresponding to its multifaceted areas of application, the SUE 3000 is set up for different switchgear arrangements.



Figure 56: SUE 3000 High Speed Transfer Device

• Permanent network comparisons

An exceptionally important characteristic, that clearly distinguishes the SUE3000 High Speed Transfer Device from competing concepts, is that synchronicity criteria are continuously available, e.g. that they are computed online by the SUE3000.

For that reason, in case of an initiation, the transfer mode which comes under consideration is already determined and can be immediately initiated. This means that the probability of a fast transfer is considerably enhanced. Systems which wait for the instant of initiation to initiate the determination of the network status have no opportunity, when one considers the physical givens, to perform a fast transfer with minimum interruption time.

• Transfer modes and times

Four different transfer modes are available in detail: Fast transfer, Transfer at the 1st phase coincidence, Residual voltage transfer, Time-operated transfer. The fast transfer is the optimum transfer mode for ensuring in case of fault that only a minimum interruption of the voltage supply occurs. In case of fast transfer the total transfer time, counting from a fault in the main feeder until the standby feeder is cut in, is less than 100ms.

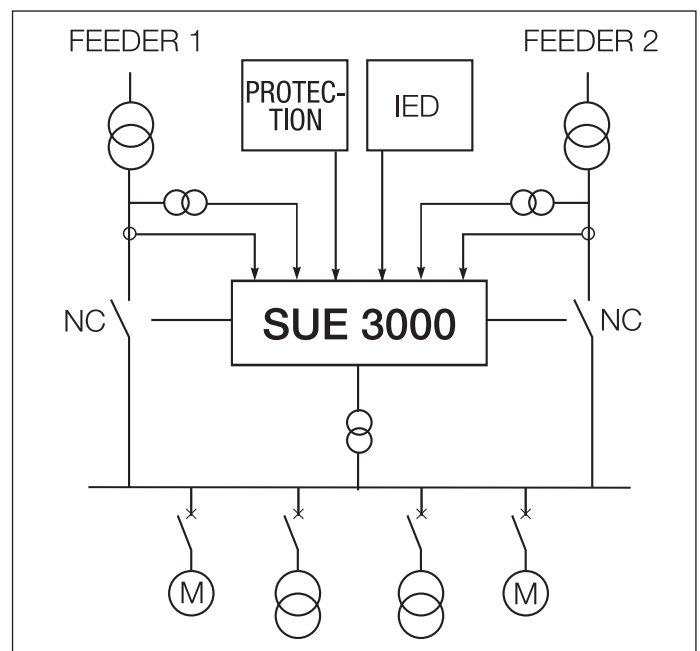
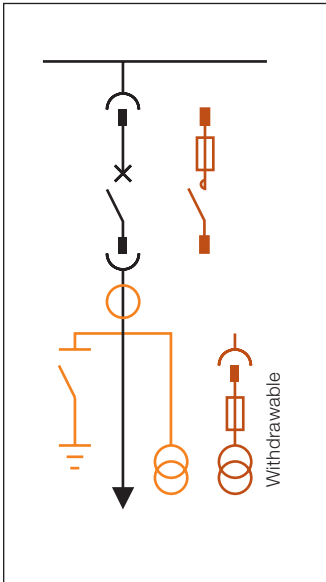


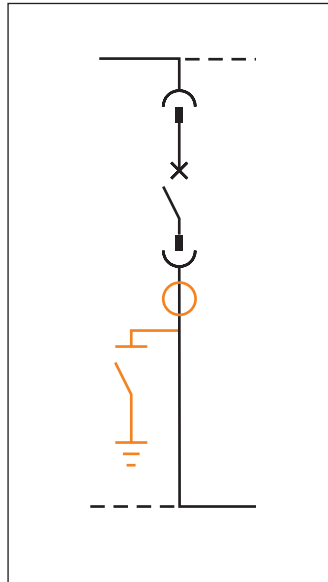
Figure 57: An example of switchgear

1. UniGear ZS1 Typical units

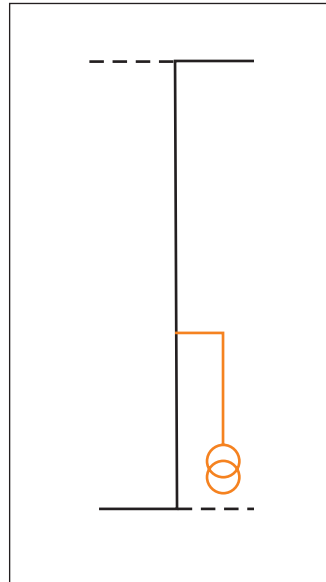
Single-line diagram of typical units



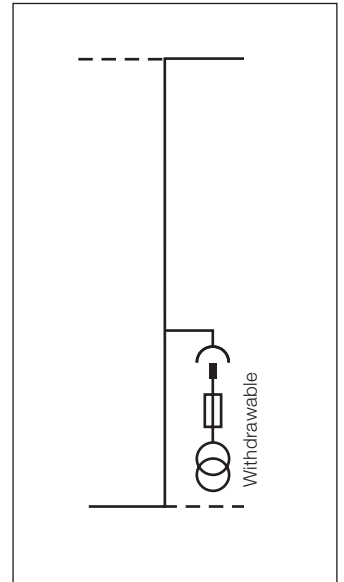
IF - Incoming/outgoing feeder



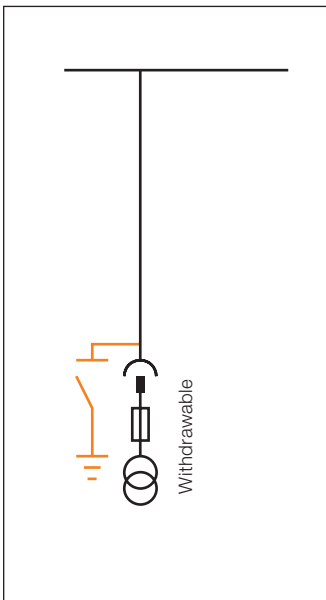
BT - Bus-tie



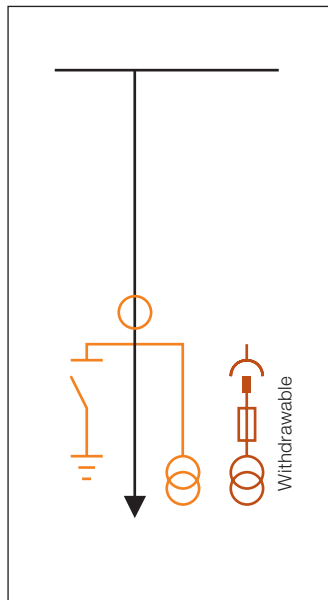
R - Riser



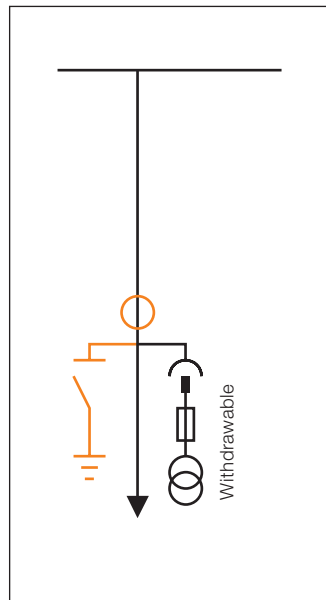
RM - Riser with measurements



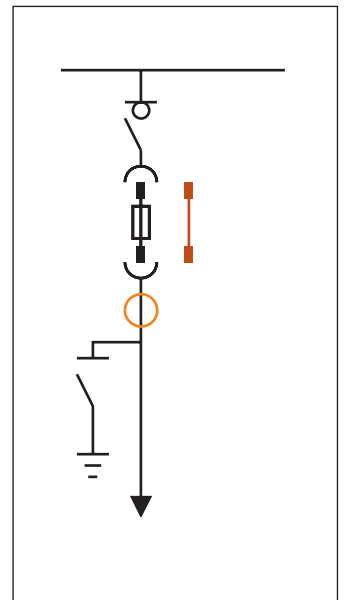
M - Measurements



IFD - Direct incoming/outgoing feeder

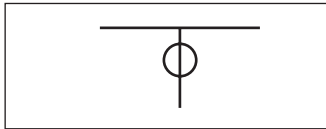


IFDM - Direct incoming/ outgoing feeder with measurements

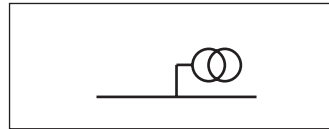


DF - Switch-disconnector unit

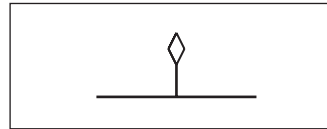
Single-line diagram of the busbar applications



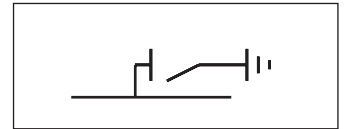
Current transformers



Voltage transformers

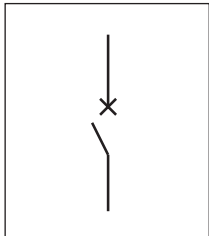


Duct entry

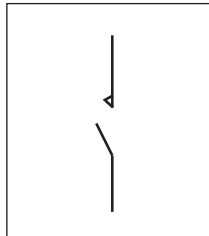


Earthing switch

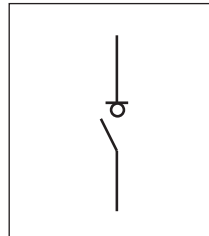
Graphical symbols



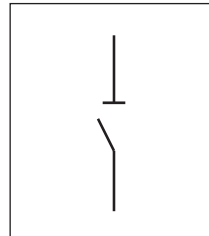
Circuit-breaker



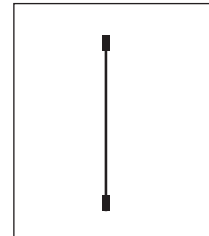
Contactor



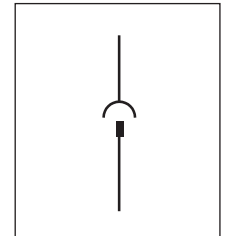
Switch-disconnector



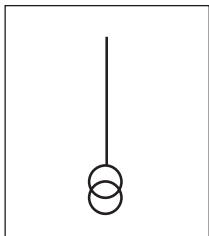
Disconnecter



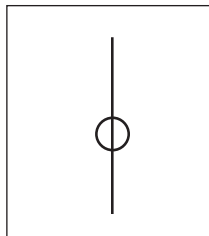
Isolating bar



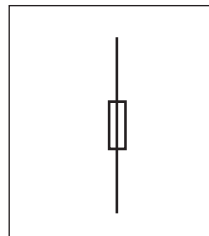
Socket and plug



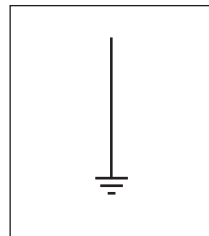
Voltage transformers



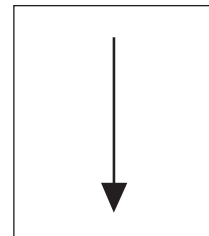
Current transformers



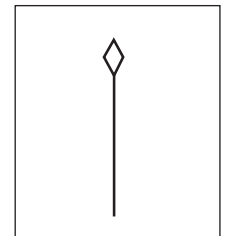
Fuse



Earth



Cable entry



Busbar entry

Key to components

— Standard components

— Accessories

— Alternative solutions

1. UniGear ZS1 - Single Busbar System

Technical data

Units: ... 12 kV - 17.5 kV - ... 31.5 kA

Width (mm)		650					800					1000								
Height (mm)		2200/2595 ⁽¹⁾					2200/2595 ⁽¹⁾					2200/2595 ⁽¹⁾								
Height with gas exhaust duct (mm)		2675 ⁽⁴⁾					2675 ⁽⁴⁾					2675 ⁽⁴⁾								
Depth (mm)		1340					1340					1390		1340		1390		1405		
Rated current (A)		630	1250	1600	2000	2500	630	1250	1600	2000	2500	3150	3600	4000	1600	2000	2500	3150	3600	4000
IF	Incoming/outgoing	(2)													(2)	(2)				
BT	Bus-tie																			
R	Riser																			
RM	Riser with measurements																			
M	Measurements																			
IFD	Direct incoming/outgoing																			
IFDM	Direct incoming/outgoing with measurement																			
DF	Switch-disconnector unit						(3)													
IFC	Contactor panel	(2), (6)																		

Units: ... 12 kV - 17.5 kV - 40 / 50 kA

Width (mm)		650					800					1000								
Height (mm)		2200/2595 ⁽¹⁾					2200/2595 ⁽¹⁾					2200/2595 ⁽¹⁾								
Height with gas exhaust duct (mm)		2700 ⁽⁴⁾					2700 ⁽⁴⁾					2700 ⁽⁴⁾								
Depth (mm)		40 kA					1340					1390		1340		1390		1405		
		50 kA					1390					1455		1390		1455				
Rated current (A)		630	630	1250	1600	2000	2500	3150	3600	4000	2000	2500	3150	3600	4000					
IF	Incoming/outgoing																			
BT	Bus-tie																			
R	Riser																			
RM	Riser with measurements																			
M	Measurements																			
IFD	Direct incoming/outgoing																			
IFDM	Direct incoming/outgoing with measurement																			
IFC	Contactor panel	(2), (6)																		

Units: ... 24 kV - ... 31.5 kA

Width (mm)		800					1000					
Height (mm)		2325/2720 ⁽¹⁾					2325/2720 ⁽¹⁾					
Height with gas exhaust duct (mm)		2733 ⁽⁴⁾					2733 ⁽⁴⁾					
Depth (mm)		1700 ⁽⁵⁾					1700 ⁽⁵⁾					
Rated current (A)		630	1250	1600	2000	2500	630	1250	1600	2000	2500	3150
IF	Incoming/outgoing											
BT	Bus-tie											
R	Riser											
RM	Riser with measurements											
M	Measurements											
IFD	Direct incoming/outgoing											
IFDM	Direct incoming/outgoing with measurement											

(1) The height of the unit is a function of the height of the low voltage compartment, available in the 705 and 1100 mm versions.

(2) For the characteristics of the unit equipped with contactor refer to page 25.

(3) For the characteristics of the unit equipped with switch-disconnector refer to page 26.

(4) Others solutions are available, please contact ABB representative.

(5) For short-time current up to 25 kA a 1560 mm depth version is available.

(6) Rated current, short current and internal arc are restricted by coordinated fuses.

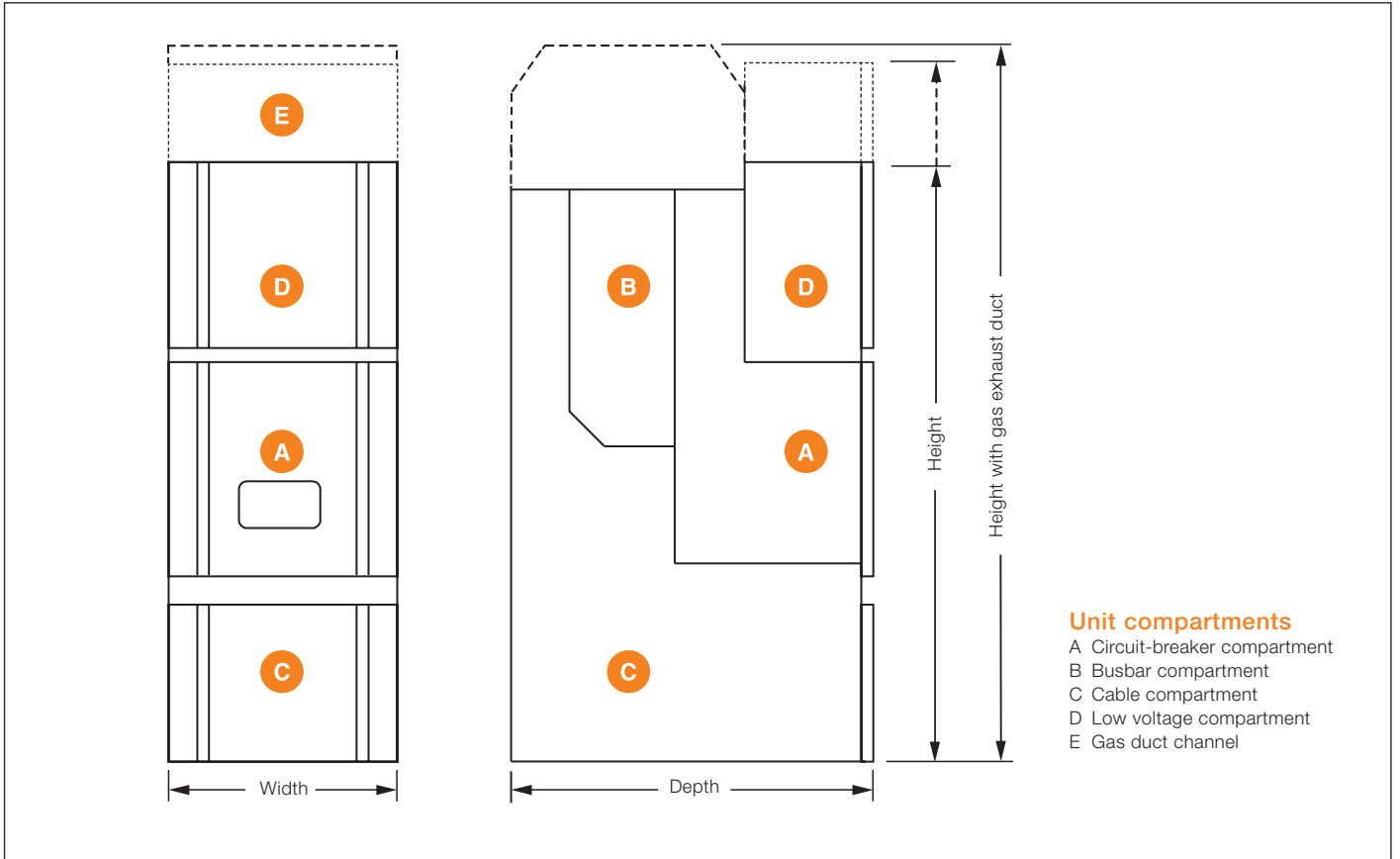


Figure 58: Example of switchgear with gas duct with top chimneys (total height of the switch-gear is 2530 mm for 12-17,5 kV up to 40 kA)



Figure 59: Example of switchgear with gas duct with outlet (total height of the switch-gear is 2675 mm for 12-17,5 kV up to 40 kA)



Figure 60: Example of UniGear ZS1 with higher LV compartment (1100 mm)





2. UniGear ZS1 - Double Busbar System Description

When ABB developed UniGear ZS1, the double busbar system was included since the beginning. The users of UniGear ZS1 double busbar system are mainly power utility companies, main substations and heavy industries. In any case the using of this product is highly recommended where there is the request to increase the service continuity.

The use of UniGear ZS1 double busbar switchgear is necessary when some of the following features are required:

- Load shedding of outgoing feeders with a different level of importance during emergency conditions;
- Isolation of particular outgoing feeders from the normal network;
- Outgoing feeders balancing on two busbar systems during normal operating condition;
- Flexibility during inspection and maintenance procedures without switchgear load interruption;
- Extension of switchgear without shutdown.
- Motor operated line-disconnector that permit fast switching between the two busbar systems during emergency situations (only possible with Bus-tie transversal closed).
- Free access to one busbar system during maintenance operations while the other is in operation and the considered unit is out of operation.
- Incoming feeders and the most important outgoing feeders can be equipped with two circuit-breakers in order to allow apparatus redundancy.



- Circuit-breaker maintenance and testing without feeder shutdown.
- Fewer number of components and less switching apparatus.

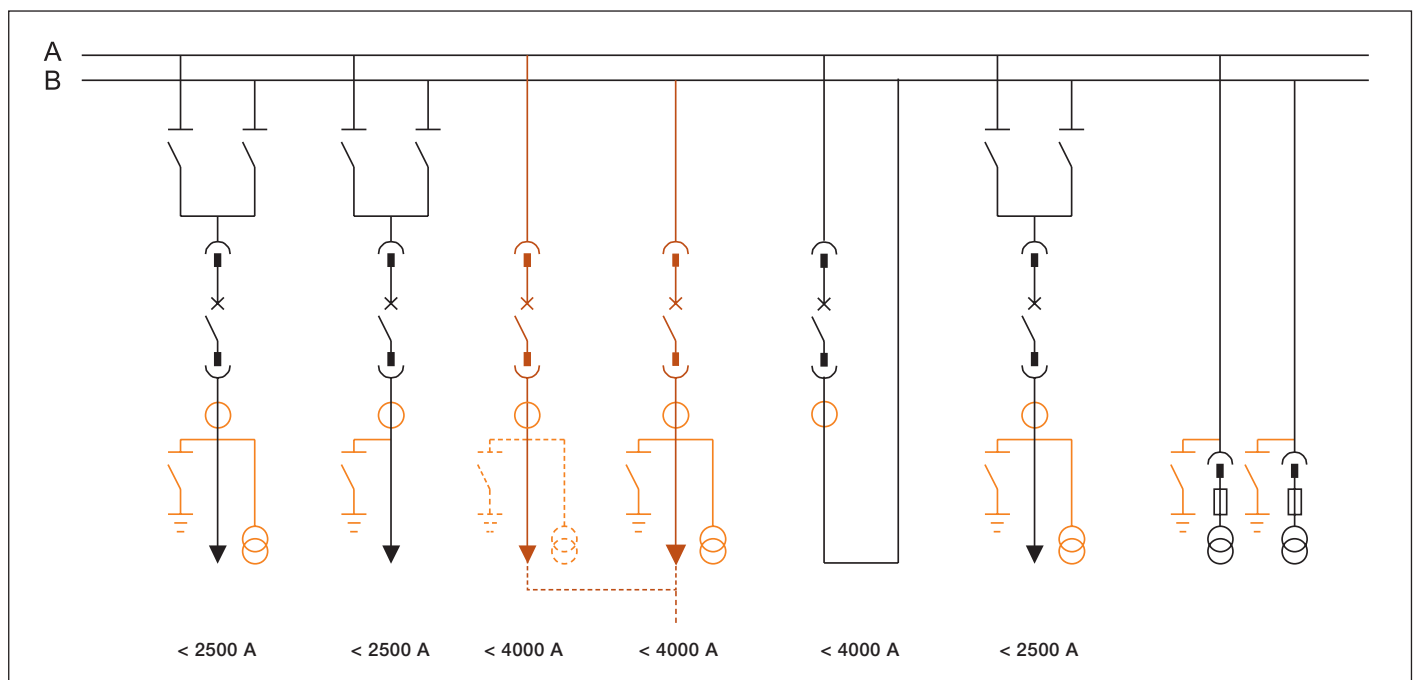


Figure 61: Example of one section of UniGear ZS1 double busbar system

The UniGear ZS1 double busbar systems are based on two different panel types:

- Two busbar systems, two busbar-disconnectors and one circuit-breaker (up to 2500 A-12-17.5 and 2000 A-24 kV);
- Two busbar systems, two circuit-breakers compartments with one or two circuit breakers, this version is called duplex system (up to 4000 A-12-17.5 kV and 2500 A-24 kV).

Both types provide full busbar system redundancy (physical isolation between source busbar systems) and allow uninterrupted and reliable service conditions.

Thanks to the numerous standard units available, the switchgear can be suitably configured to satisfy all configuration requirements.

Each switchgear panel can be equipped with circuit-breakers. All the significant components and accessories are identical to those used for UniGear ZS1 single level and double level units and therefore the same operation and maintenance procedures are guaranteed.

ABB double busbar system can be provided with single section or two or more sections in order to satisfy the most demanding customer request.

For examples refer to the two sections:

- One section of double busbar (please refer to figure 61).
- Two sections of double busbar (please refer to figure 62).

IEC electrical characteristics

Rated voltage	kV	12	17.5	24
Test voltage	kV 1 min	28*	38*	50
Impulse withstand voltage	kV	75	95	125
Rated frequency	Hz	50/60	50/60	50/60
Rated short-time withstand current	kA 3 s up to	31.5	31.5	25
Peak withstand current	kA up to	80	80	63
Internal arc withstand current	kA 1 s up to	31.5	31.5	25
Rated current of the main busbars	A up to	4000	4000	2500
Rated circuit-breaker thermal current	A up to	4000	4000	2500
		630	630	630
		1250	1250	1250
Double busbar-disconnector feeders rated current	A	1600	1600	1600
		2000	2000	2000
		2500	2500	-
Duplex feeder rated current	A	3150	3150	-
Duplex feeders rated current with forced ventilation	A	3600	3600	2500
		4000	4000	-

1) For other versions, please refer to the chapters nr.1 (Single Level) and chapter nr.3 (Double level).

2) The values indicated are valid for both vacuum and SF6 circuit-breaker.

3) For panel with contactor the rated current value is 400 A.

* 42 kV (GB/DL)

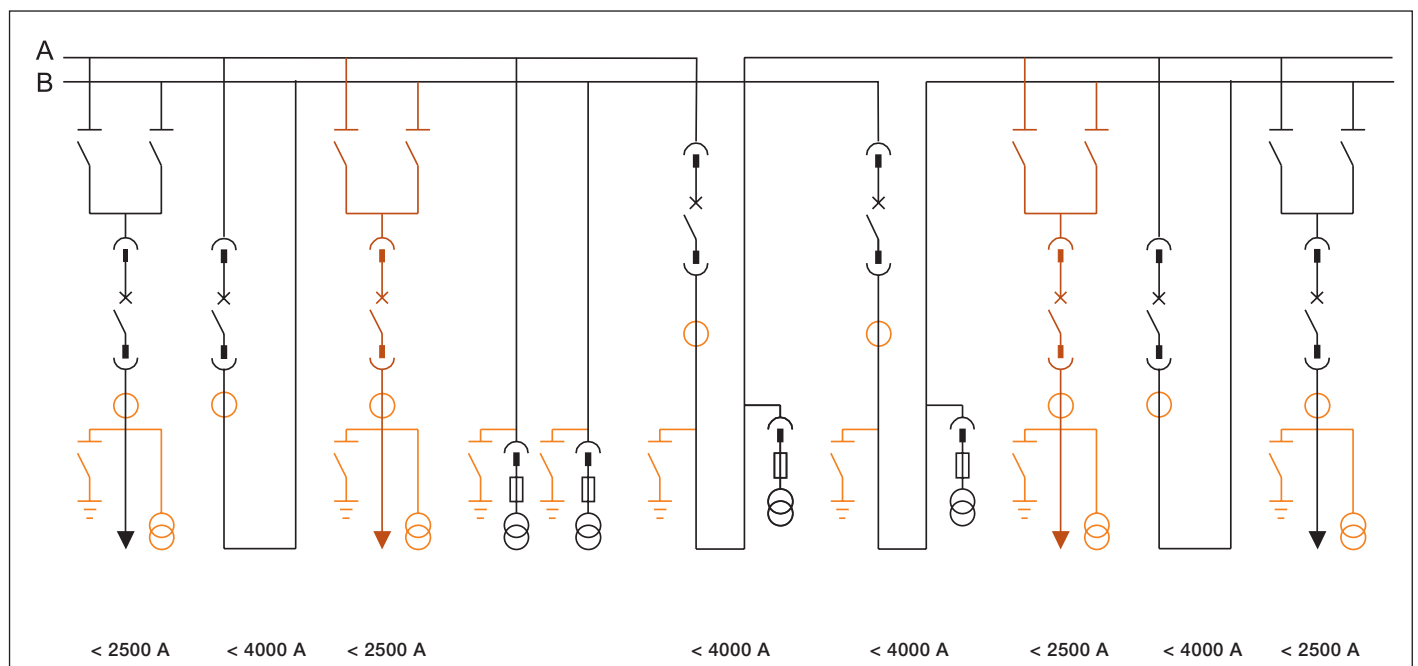


Figure 62: Example of two sections of UniGear ZS1 double busbar system

2. UniGear ZS1 - Double Busbar System Characteristics

Compartments

Each panel is made up of four independent power compartments: apparatus (A), busbar 1 (B1), busbar 2 (B2) and cable (C), please refer to page 69.

There is a metallic segregation between all the compartments. In its front/top part the panel is fitted with a compartment to take the auxiliary instruments (D).

UniGear ZS1 double busbar system is arc-proof version and supplied with a duct for the evacuation of the gases produced by an arc (E).

Each compartment of the unit is fitted with a flap on the top surface. The pressure generated by the fault makes this open, allowing the gas to pass into the duct.

The apparatus compartment is accessible from the front. Door closing of these compartments is available in two versions, with screws or central handle.

Removal of the apparatus from the switchgear (circuit-breakers and contactors) and from its relative compartments takes place by means of a single dedicated truck.

The busbar and cable compartment are accessible from the rear of the switchgear by means of removable panels. All the normal service operations are carried out from the front, whereas maintenance and start-up operations also require access from the rear of the switchgear.

Busbar disconnectors

IF unit busbar-disconnectors are designed to act as two position switches - open and closed positions - and operation is manual (e.g. without springs assistance).

The opening and closing operation of the busbar-disconnector is operated from the front of the panel.

The position of the busbar-disconnector is indicated on the front of the panel with mechanical coupled indicators.

The busbar-disconnectors are clearly separated and the relevant busbar compartments are segregated from each other in order to achieve the following:

- It should be possible to carry out maintenance and also extend the switchgear with additional units, keeping one of the two busbars systems energised.
- A fault generated in one compartment (e.g. insulation discharge) will not generate any damage to the others or require the shutdown of the unit.

Busbar-disconnectors are provided with limit switches for the detection of operating position and they can be operated manually or, as an option, motor operated.

The busbar-disconnectors are provided with the necessary interlocking facilities.

The interlocks between the two line disconnectors and the circuit breaker are implemented by means of locking magnets.

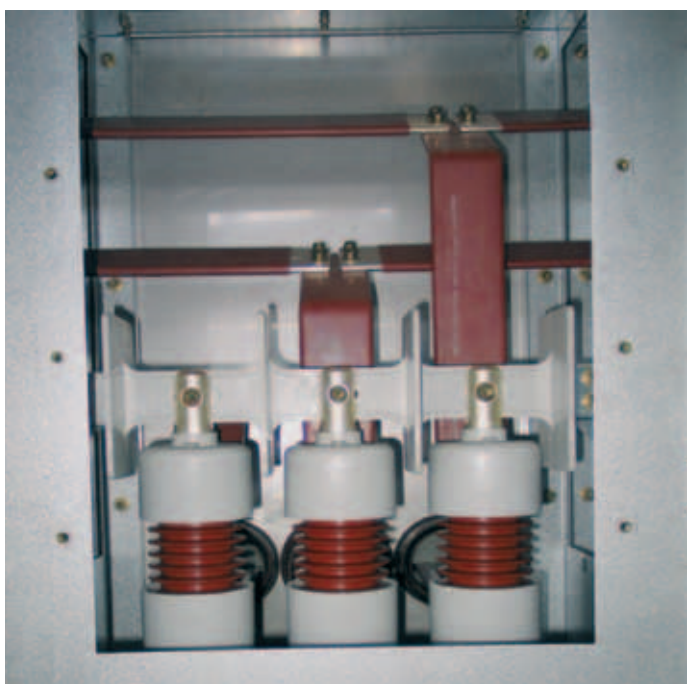


Figure 63: Closed position of busbar-disconnector

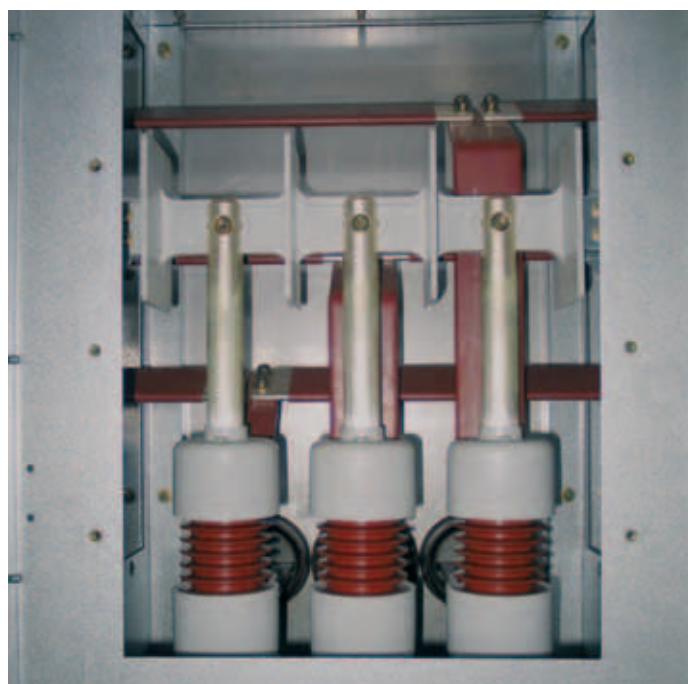


Figure 64: Open position of busbar-disconnector

The busbar-disconnector consists of a moveable copper tube housed inside an epoxy insulator. Electrical contact is guaranteed by two or four connection springs (depending on the rating of the disconnector). Additional protective insulating caps are mounted on both sides of the insulator, thus providing the device with a high level of reliability.



Figure 65: Front panel with operating slots of busbar-disconnector

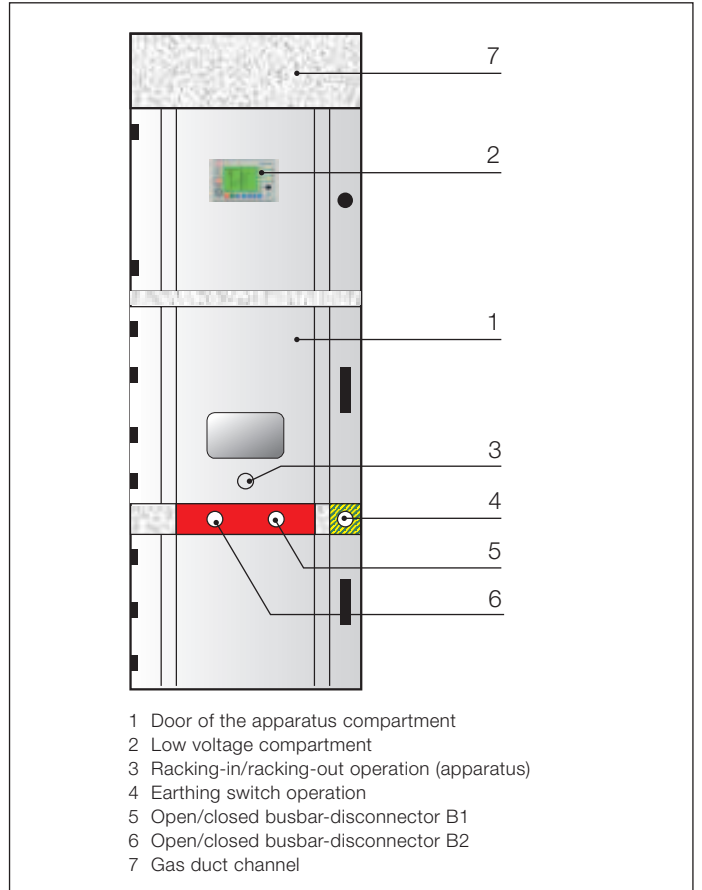


Figure 66: Double busbar system with two busbar-disconnector

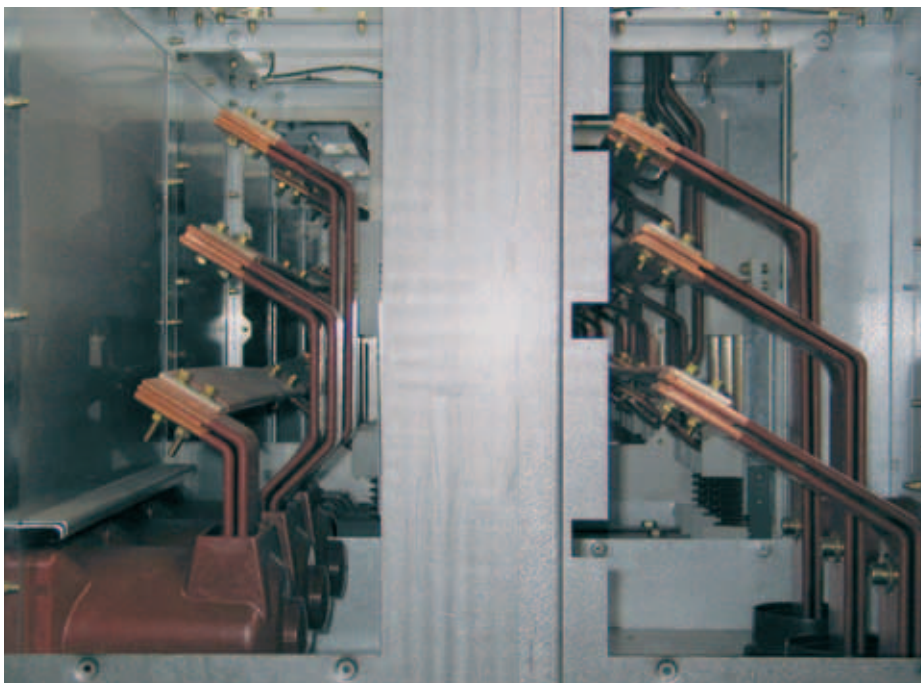
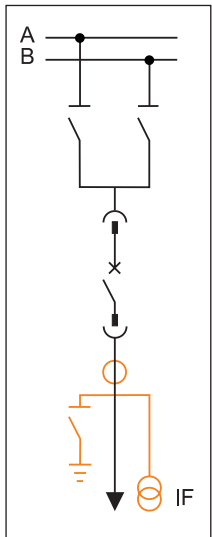


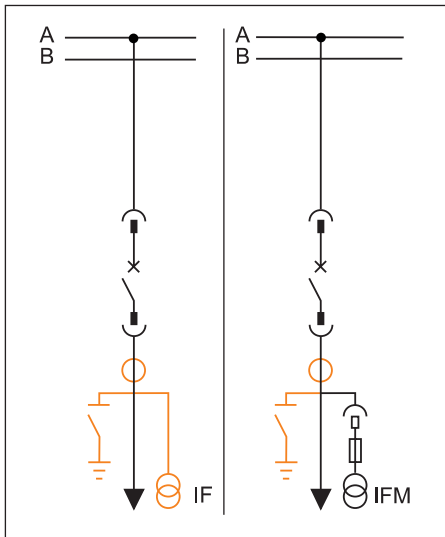
Figure 67: The two busbar compartments

2. UniGear ZS1 - Double Busbar System Typical units

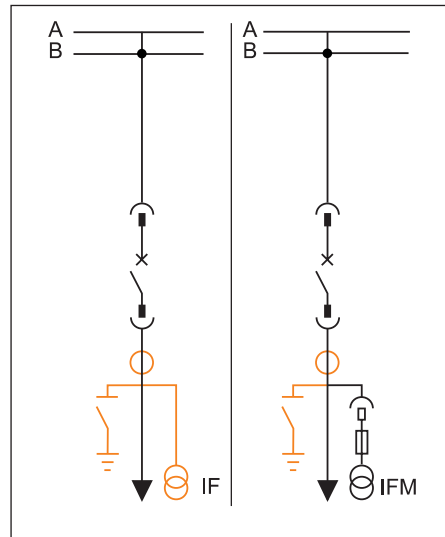
Single-line diagram of typical units



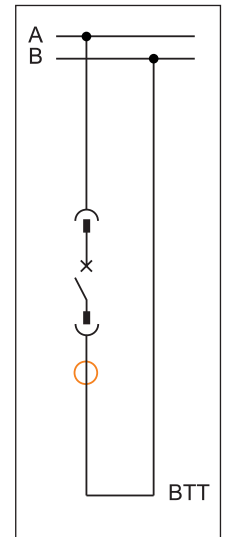
IF - Incoming/Outgoing



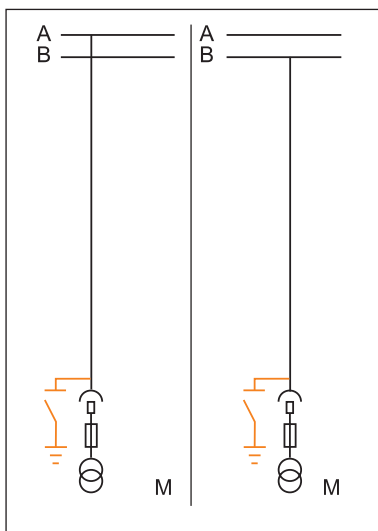
IF and IFM - Busbar A Duplex



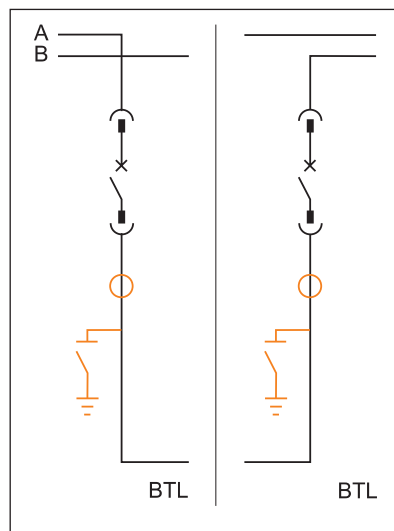
IF and IFM - Busbar B Duplex



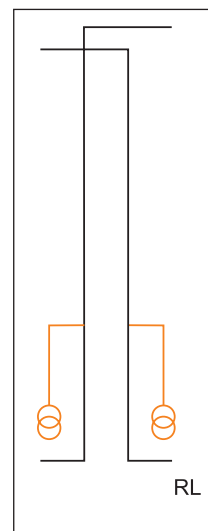
BTT - Transv. Bus Tie



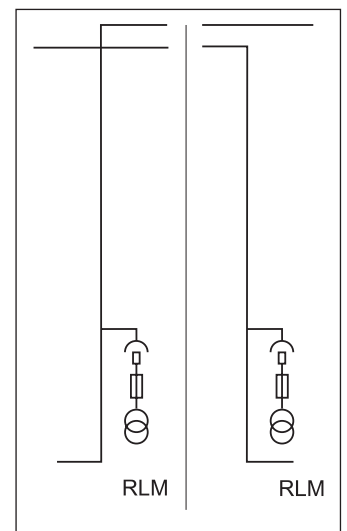
M - Measurements



BTL - Longitudinal Bus Tie

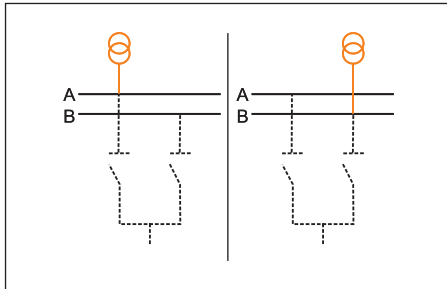


RL - Bus Riser Longitudinal

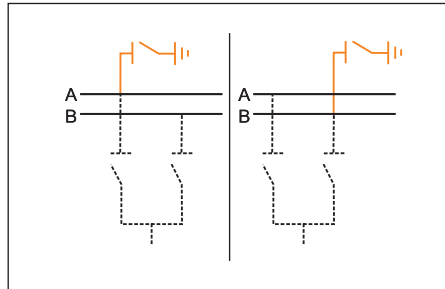


RLM - Bus Riser Longitudinal with Metering

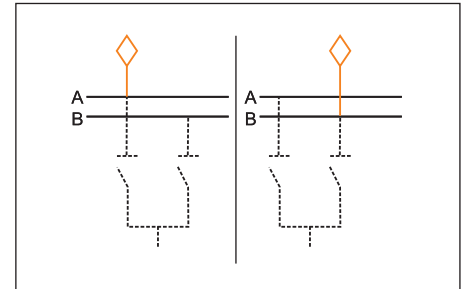
Busbar applications



Top-mounted VTs



Top-mounted earthing switch



Top entry duct

Key to components

— Standard components

— Accessories

— Alternative solutions

2. UniGear ZS1 - Double Busbar System Technical data

Units ... 12 - 17.5 kV - ... 31.5 kA

Depth (mm)		2021					2021					2021				
Height (mm)		2200/2595 ⁽¹⁾					2200/2595 ⁽¹⁾					2200/2595 ⁽¹⁾				
Height with gas exhaust duct (mm)		2700 ⁽²⁾					2700 ⁽²⁾					2700 ⁽²⁾				
Width (mm)		650					800					1000				
Rated current (A)		630	1250	1600	2000	2500	1600	2000	2500	3150	3500	4000	2500	3150	3500	4000
IF	Incoming/outgoing															
IF	Incoming/outgoing duplex feeder															
IFM	Incoming/outgoing duplex feeder with measurements															
BTT	Transverse bus-tie															
M	Measurements															
BTL	Longitudinal bus-tie															
RL	Longitudinal riser															
RML	Longitudinal riser with measurements															

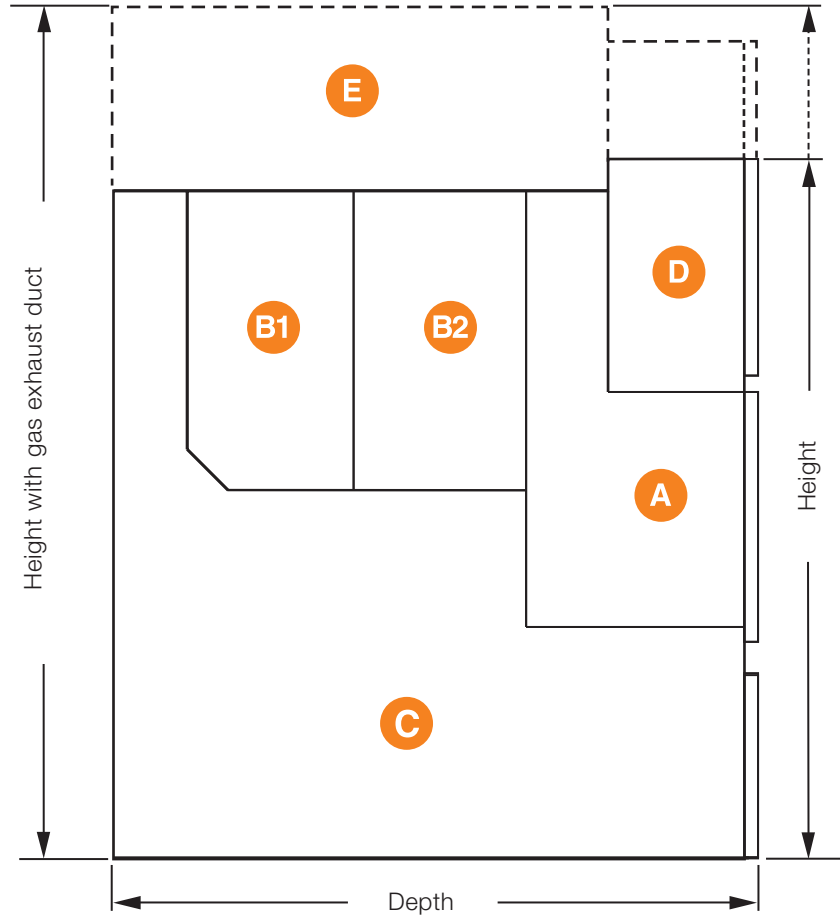
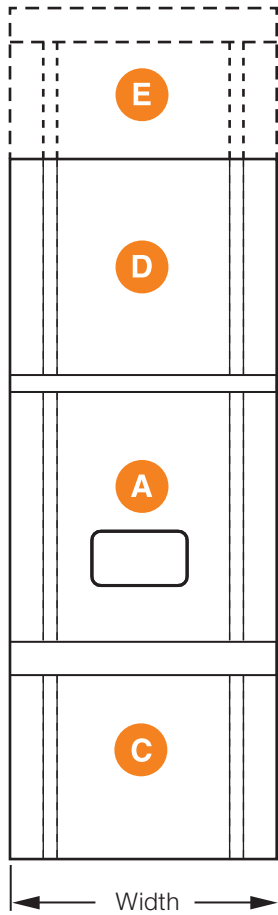
Units ... 24 kV - ... 25 kA

Depth (mm)		2570					2570					
Height (mm)		2400/2720 ⁽¹⁾					2400/2720 ⁽¹⁾					
Height with gas exhaust duct (mm)		3000 ⁽²⁾					3000 ⁽²⁾					
Width (mm)		800					1000					
Rated current (A)		630	1250	1600	2000	2500	1600	2000	2500			
IF	Incoming/outgoing											
IF	Incoming/outgoing duplex feeder											
IFM	Incoming/outgoing duplex feeder with measurements											
BTT	Transverse bus-tie											
M	Measurements											
BTL	Longitudinal bus-tie											
RL	Longitudinal riser											
RLM	Longitudinal riser with measurements											

IF and IFM duplex feeder, M, BTL, RL and RLM are available for both A and B busbar system connections.

1) The height of the unit is a function of the height of the low voltage compartment, available in the 705 and 1100 mm versions.

2) Other solutions are available, please contact ABB representative.



Unit compartments

- A Apparatus compartment
- B Busbar compartment
- C Cable compartment
- D Low voltage compartment
- E Gas duct channel





3. Marine applications

Description

The Marine Market is divided into four different segments:

- Passenger vessels (cruise ships and ferries).
- Industrial vessels (shuttle tankers, drill ships, oil carriers, cargo vessels, etc.).
- Rigs (drill and oil rigs).
- Navy.

In this type of application the temperature range, vibrations and variable inclination are particularly severe conditions that impact the functional requirements of on-board components such as the switchgear.

ABB is the leading manufacturer of air-insulated switchgear for marine applications, installed by all main shipyards (Brazil, China, Denmark, Finland, France, Germany, Japan, Korea, Italy, Norway, Singapore, Spain, UK and USA).

The switchgear suitable for marine applications is UniGear ZS1 in single and double level arrangement up to 7.2-12 kV rated voltage (with the option for 17.5 kV), with the need for many dedicated features and some special typical units. Over 10,000 ABB panels are in service in the world on board all kind of ships.

Registers and end-customers (shipyards or ship owners) require switchgear manufactured to comply with Shipping Register test requirements for on-board apparatus.

For this purpose, tests have been performed in compliance with the main Shipping Register regulations; DNV, LR, RINA, BV, GL, ABS, KR and Russian regulations.

In order to guarantee the necessary comfort and facilities, high power generation plants and control systems must be concentrated in significantly reduced overall dimensions. UniGear ZS1 can be offered in single level with the possibility to be coupled with double level; it offers a wide range of apparatus and control units to satisfy marine installation requirements.

UniGear ZS1 switchgear provides the ideal technical solutions for marine applications:

- Arc-proof construction, mechanical safety interlocks, automatic segregation shutters and apparatus control with the door closed guarantee personnel safety during installation, operation and maintenance;
- High degree of protection (up to IP43) on the external enclosure;
- Metallic partitions between each compartment and earthing of all components accessible to personnel: apparatus, shutters, doors and the whole switchgear frame;
- High fire resistance thanks to minimal use of plastic and resins: the auxiliary equipment and wiring are highly self-extinguishing.



Figure 68: UniGear ZS1 single level for marine application





Shore connection

Ships generate emissions while docked in port by running their auxiliary engines to create onboard electric power.

In ports with heavy ship traffic, this practice creates emissions and negative health and environmental impact to the local surrounding communities.

As global trade steadily expands, ship emissions represent an ever-increasing environmental concern.

Sustainability is today a key area of focus in the shipping industry, where strong measures are being taken on several fronts to dramatically reduce ship emissions. One such measure is shore-to-ship electric power supply, which eliminates pollution problems and particle discharge as well as noise and vibration from ships in port. UniGear ZS1 Shore Connection panel is delivered as a finished cabinet solution with both a power module and a control module.

Depending on the system configuration and onboard requirements, the cabinet may be supplied with cable connectors located in the front of the cabinet or with openings for cable entry through the cabinet floor.

All equipment is constructed and factory tested according to international standards and classification society rules.

Ambient conditions for classification of on-board apparatus

- Ambient temperature from 0 °C to + 45 °C
- Inclination up to 25° permanent

Vibration in the frequency range of 2 ... 100 Hz at the following motion width

- 1mm amplitude in the frequency range of 2...13.2 Hz
- 0.7g acceleration amplitude in the frequency range of 13.2...100 Hz

Fully type tested

The UniGear ZS1 switchgear has undergone all the tests required by the international (IEC), in addition, the tests required by the main shipping registers (LR, DNV, RINA, BV, GL, KR and Russian) have been carried out for use of the switchgear in marine installations.

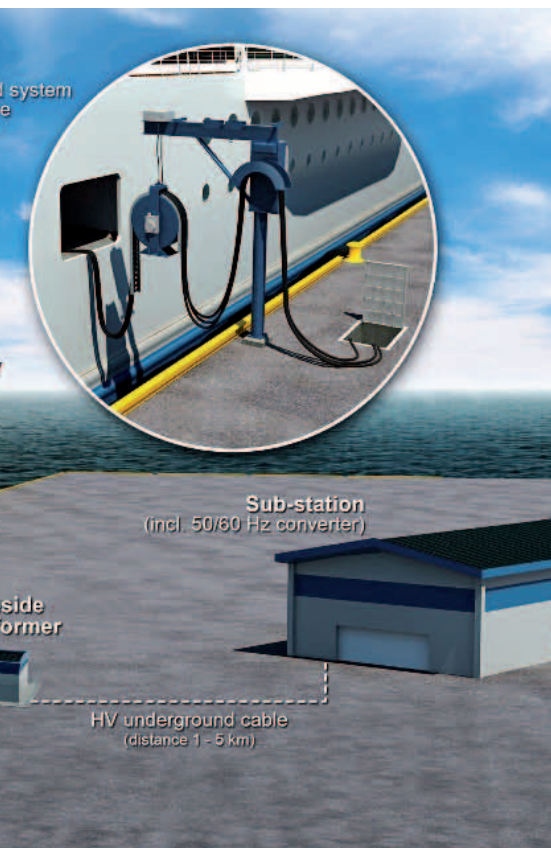
For more information about dedicated tests required by main shipping registers, please refer to page 13.

IEC electrical characteristics

Rated voltage	kV	7.2	12
Rated insulation voltage	kV	7.2	12
Rated power frequency withstand voltage	kV 1 min	20	28
Rated lightning impulse withstand voltage	kV	60	75
Rated frequency	Hz	50 / 60	50 / 60
Rated short-time withstand current	kA 3 s	...50	...50
Peak current	kA	...125	...125
Internal arc withstand current	kA 1 s	...40	...40
	kA 0.5 s	...50	...50
Main busbar rated current	A	1250...4000	1250...4000
Circuit-breaker rated current	A	630...3150	630...3150
Circuit-breaker rated current with forced ventilation	A	3600...4000	3600...4000

1) The values indicated are valid for both vacuum and SF6 circuit-breaker.

2) For panel with contactor the rated current value is 400 A.



3. Marine applications

Characteristics

The features required for marine application, which are not part of the standard design, are described here below.

Degree of Protection

On request, the external housing of UniGear ZS1 can be supplied with different degrees of protection, the standard one requested for marine application is IP42 or IP43; where:

- IP42: protection against foreign bodies with diameter 1mm and against water ingress at 15° maximum inclination;
- IP43: protection against foreign bodies with diameter 1mm and against water ingress at 60° maximum inclination.

Duct for secondary wirings

On the top of the switchgear and exactly above the low voltage compartment as an option can be supplied the wiring duct.

Into this duct there are positioned the terminal boards related to the interpanel wiring between panels.

Gas duct

UniGear ZS1 is arc-proof version and supplied with a duct for the evacuation of the gases produced by an arc.

The duct is fixed on the top of the auxiliary compartment.

In marine plants, the exhaust gases cannot normally be evacuated out of the room and therefore the gas duct must always be closed on both the end-sides and equipped with top chimneys.

If there are cases where it is possible to evacuate hot gases out of the room, the gas duct with outlet can be supplied.

Doors

The door of the apparatus compartment and the rear panel is always supplied with handrails.

In addition, all the doors (low voltage, apparatus and cable compartments) are equipped with an appropriate stop to fix them in the open position.

Cables

UniGear ZS1 single level

Single level IF and IFM units are usually delivered in the deeper version (1650-1700 mm). This design will allow the following targets to be achieved:

- bottom and top cable entry;
- appropriate cable terminal distance (minimum requirements):
 - 700 mm in case of bottom entry;
 - 1000 mm in case of top entry.

Standard depth IF units (1340-1390 mm) are also used as an alternative in case of problems with space.

This feeder version will only allow bottom cable entry and a cable terminal distance in the range of 440...535 mm, depending on the rated current.

UniGear ZS1 double level

All the described recommendations for single level units must be applied to double level units.

The cable terminal distance of IF units is 600 mm for all the following configurations:

- Bottom entry (both feeders);
- Top entry (both feeders);
- Bottom and top entry (one feeder from top, one feeder from bottom).

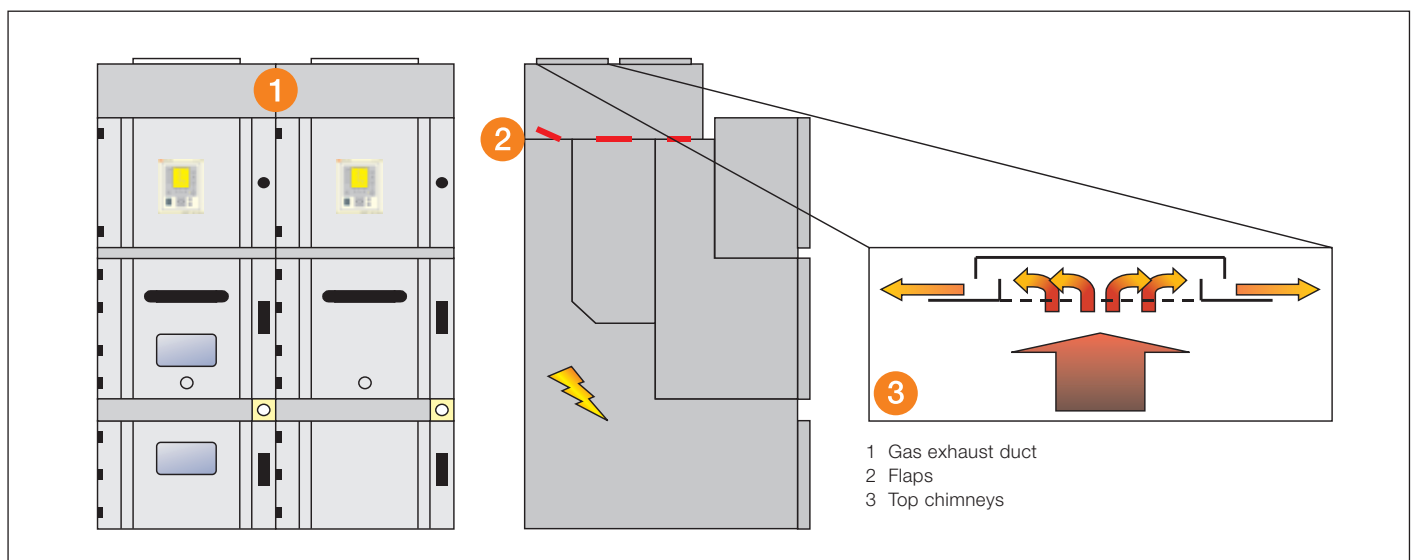
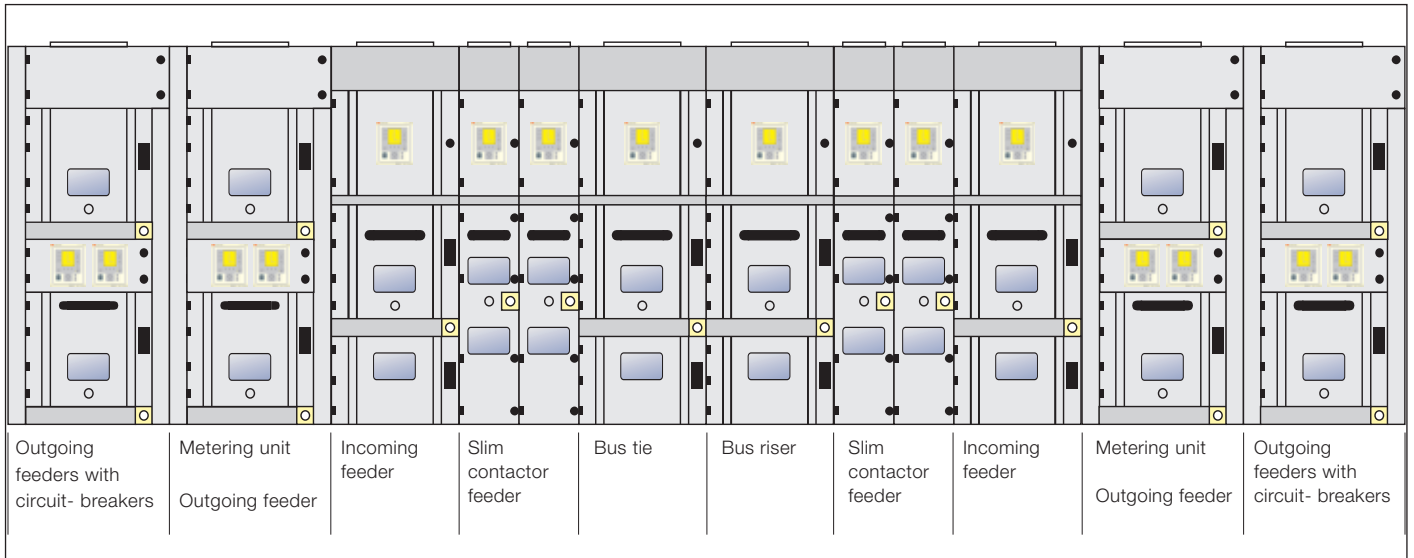


Figure 69: UniGear ZS1 with compact gas duct with top chimneys

Mixed configuration with single level, double level and motor control center



Thermo-graphic inspection

Thermographic inspection is normally required on power cable terminations and sometimes on main busbar systems.

Customers are normally much more sensitive to the former, because cable termination faults represent a considerable percentage of all the faults in switchgear, whereas faults in main busbar systems are quite rare.

Thermo-graphic inspection and supervision can be done in two ways:

- Temporary inspection by means of an IR camera through an appropriate inspection window;
- Continuous supervision by means of IR sensors located inside the switchgear.

The first system (temporary inspection) requires an IR camera and an inspection window for each compartment to be supervised.

The second system (continuous supervision) requires the continuous thermal monitoring.

This is a non-touch temperature monitoring system based on IR temperature probes connected to a central unit (up to 8 sensors can be plugged in to each central unit).

Due to the switchgear design constraints, the main busbar Thermo-graphic inspection can only be carried out using the continuous thermal monitoring system.

The power cables can be supervised with both solutions.

With regard to UniGear ZS1 double Level, we can point out that due to the switchgear design constraints, both the main busbar and the power cables thermo-graphic inspection can only be carried out using the continuous thermal monitoring system.



Figure 70: Example of Thermo-graphic senso in UniGear ZS1 single level

3. Marine Applications

Typical units

For the typical units used in marine application please refer to page 58 for UniGear ZS1 single level and page 86/87 for UniGear ZS1 double level. The required units, which are not part of the standard design, are described here below.

Earthing transformer units

From the electrical point of view, marine plants are based on isolated networks (isolated neutral point).

The main consequences are as follows:

- the network can be operated with single-phase earth fault;
- earth fault detection is very difficult, due to the very low earth fault current.

In order to increase this and therefore allow releases to operate on single-phase earth faults, two solutions can be used:

- connecting the secondary winding of the generator to ground by means of a resistor;
- installing an earthing transformer in the network.

For this reason, the UniGear ZS1 range must be enhanced with two additional typical units:

- ME: Busbar metering unit with earthing transformer feeder;
- RE: Rise with earthing transformer feeder.

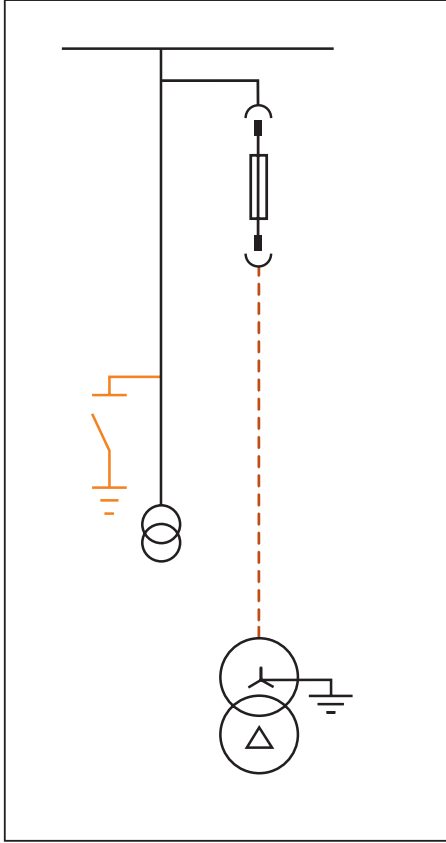
In the case of switchgear with a single busbar section, ME can be used for this purpose; in the case of switchgear equipped with two busbar sections, both ME and RE units must be used, in order to cover all the schemes.

Additional features of Measurement and Riser units

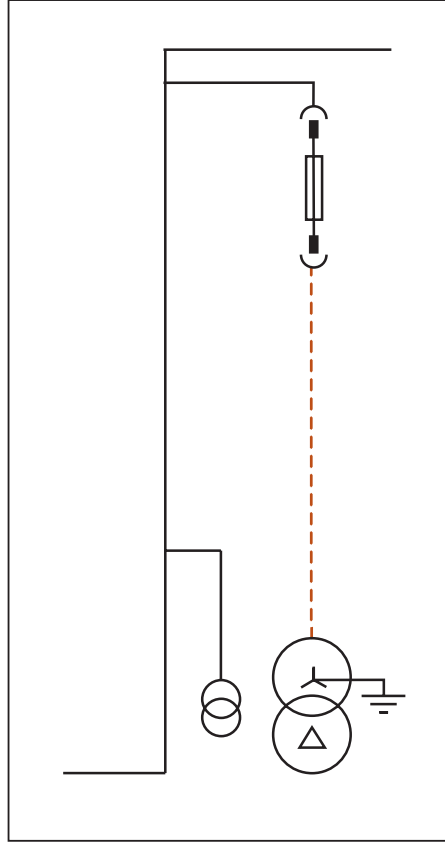
Out of choice, M and R units should be equipped with fixed Voltage Transformers instead of withdrawable VT's with fuses. In this configuration the "apparatus compartment", where is placed the VT's truck, will be used as an additional auxiliary compartment. It is fully segregated from the power compartments with metallic partitions and designed as a low voltage compartment with respect to the safety rules.

The inside rear and side walls of the compartment is fitted with the grid plate for fixing the auxiliary equipment.

This will be equipped with the relevant left-hand side duct for wiring entry from the bottom and exit to the top-mounted Low voltage compartment.



ME – Metering with earthing transformer



RE – Bus Riser with metering and earthing transformer

3. Marine Applications

Technical data

7.2 - 12 kV - ... 31.5 kA

Unit width (mm)		650				
Unit depth (mm)		1650				
Rated current (A)		630	1250	1600	2000	2500
IF	Incoming/outgoing duplex feeder (1)	(3)				
IFM	Incoming/outgoing duplex feeder with measurements (1)	(3)				
Unit width (mm)		650				
Unit depth (mm)		1340				
Rated current (A)		630	1250	1600	2000	2500
IF	Incoming/outgoing feeder (2)	(3)				
BT	Bus-tie					
R	Riser					
RE	Riser with earthing transformer					
RM	Riser with measurements					
M	Measurement					
ME	Measurement with earthing transformer					

(1) Bottom and top cable entry

(2) Bottom cable entry

(3) Up to 50 kA with vacuum contactor

7.2 - 12 kV - ... 40-50 kA

Unit width (mm)		650						1000							
Unit depth (mm)		1650			1700			1650			1700				
Rated current (A)		400	1250	1600	2000	2500	3150	4000	630	1250	1600	2000	2500	3150	4000
IF	Incoming/outgoing feeder ⁽¹⁾	(³)													
IFM	Incoming/outgoing with measurements ⁽¹⁾	(³)													

Unit width (mm)		650						1000							
Unit depth (mm)		1340			1390			1340			1390				
Rated current (A)		400	1250	1600	2000	2500	3150	4000	630	1250	1600	2000	2500	3150	4000
IF	Incoming/outgoing feeder ⁽²⁾	(³)													
BT	Bus-tie														
R	Riser														
RE	Riser with earthing transformer														
RM	Riser with measurements														
M	Measurement														
ME	Measurement with earthing transformer														

(1) Bottom and top cable entry

(2) Bottom cable entry

(3) Up to 50 kA with vacuum contactor

3. Marine Applications

UniGear ZS1 Double Level Description

UniGear ZS1 is also available as single busbar system in the double level configuration. Each panel consists of two completely independent superimposed units and is functionally identical to two single-level units placed side by side.

Thanks to the numerous standard units available, the switchgear can be suitably configured to satisfy all installation requirements. Each unit can be equipped with circuit-breakers or contactors, as well as with all the accessories available for UniGear ZS1 single level units.

All the significant components are identical to those used for the single-level units and therefore the same service and maintenance procedures are guaranteed.

The UniGear ZS1 double level switchgear is mainly distinguished by its efficient use of space. All the configurations allow a drastic reduction in the space occupied, with special regard to the width of the switchgear (30...40% less in typical configurations).

Its use is recommended in installations with a high number of feeders, fitted with either circuit-breakers or contactors.

It can be used as a motor control center for applications up to 12 kV.

All the electrical characteristics of the double and single level units are identical.

The overall rated current of the busbar system is given by the sum of the currents of the two top and bottom half-busbars.

The double-level units can be coupled directly to single-level



units, with the possibility of extension on both sides of the switchgear.

The switchgear requires access from the rear for the installation and maintenance procedures, while all the service operations are carried out from the front.

The UniGear ZS1 double level switchgear can be used in two typical configurations:

- Complete with double-level.
- Compound with simple and double-level.

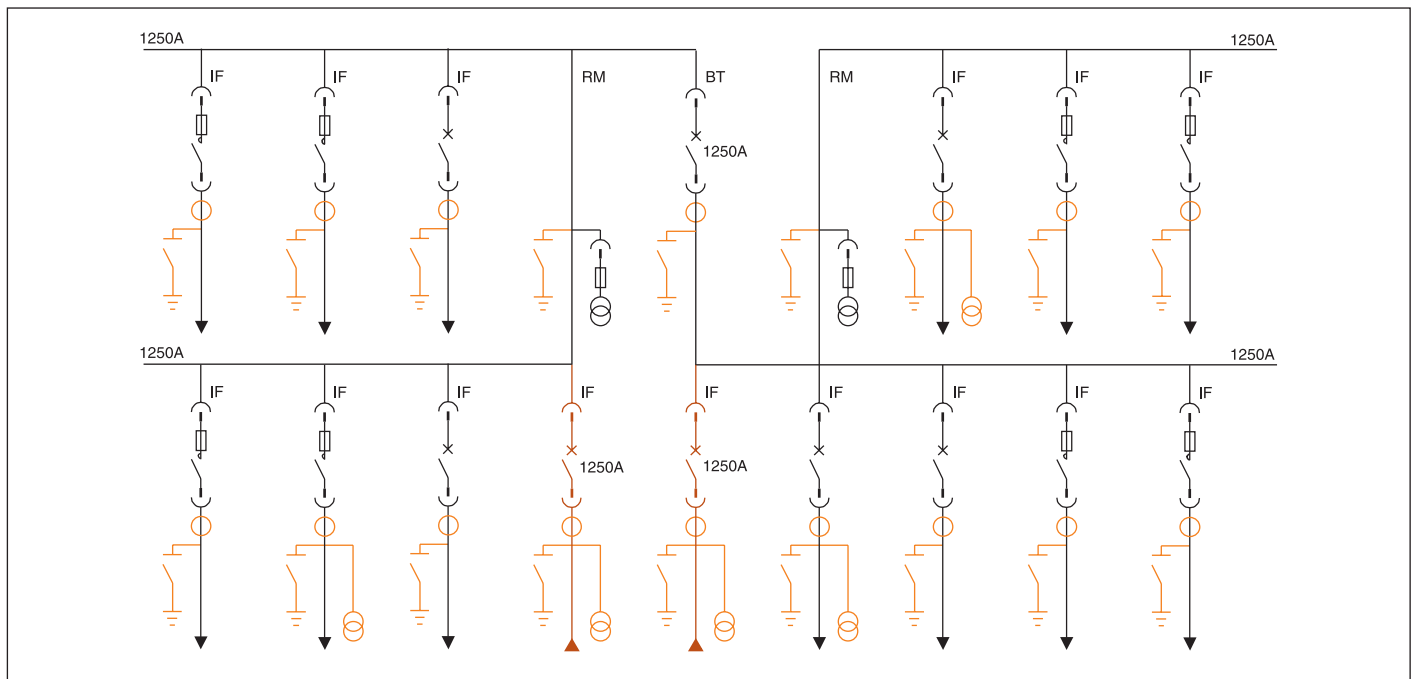


Figure 71: Example of complete UniGear ZS1 double level configuration

The complete solution only uses double level panels to realise all the standard units: incoming feeders, bus-tie, riser, busbar measurement and outgoing units.

The compound solution in contrast, uses both the simple and double level solution: the former for the incoming feeders, bus-tie and riser compartments, the latter for the busbar measurement and outgoing units.

The complete double level solution makes it possible to achieve the maximum reduction in installed dimensions

and can be used for relatively limited rated currents (1600 A maximum current of the incoming feeders). It is normally used to construct local distribution switchgear, with a limited number of outgoing feeders.

The field of application of the compound solution is aimed at main distribution switchgear, with high rated currents (3150 A maximum current of the incoming feeders) and numerous outgoing feeders.

IEC electrical characteristics

Rated voltage	kV	7.2	12	17.5
Rated insulation voltage	kV	7.2	12	17.5
Rated power frequency withstand voltage	kV 1 min	20	28	38
Rated lightning impulse withstand voltage	kV	60	75	95
Rated frequency	Hz	50 / 60	50 / 60	50 / 60
Rated short-time withstand current	kA 3 s	...50	...50	...40
Peak current	kA	...125	...125	...105
Internal arc withstand current	kA 1 s	...40	...40	...40
	kA 0.5 s	...50	...50	–
Main busbar rated current	A	...1600	...1600	...1600
		630	630	630
		1000	1000	1000
Circuit-breaker rated current		1250	1250	1250
		1600	1600	1600

1) GB/DL version is available with higher request in dielectric characteristics (42 kV) and short time withstand current (4 s).

2) The values indicated are valid for both vacuum and SF6 circuit-breaker.

3) For panel with contactor the rated current value is 400 A.

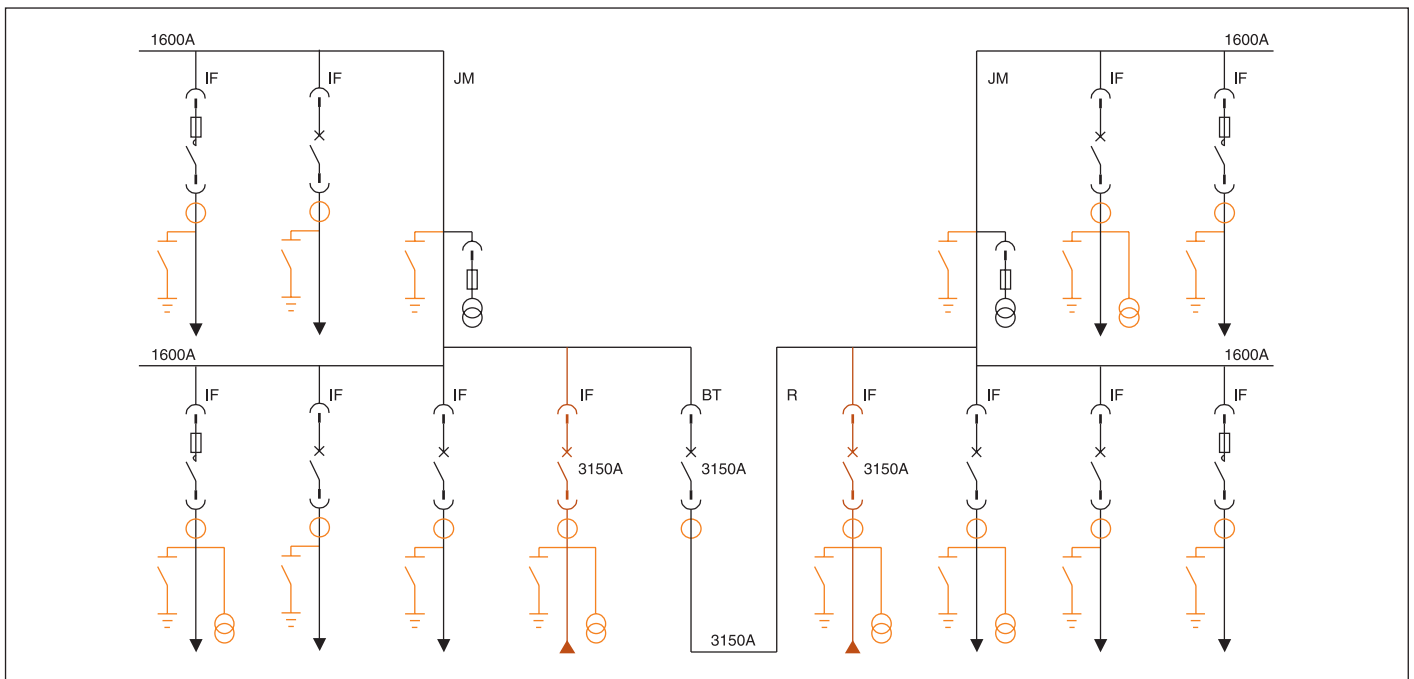


Figure 72: Example of UniGear ZS1 single and double level configuration

3. Marine Applications

UniGear ZS1 Double Level Characteristics

Compartments

Each panel consists of two superimposed units [1st level and 2nd level] and each unit is therefore made up of three independent power compartments: apparatus [A], busbar [B] and cable [C] (please refer to page 89).

There is metallic segregation between all the compartments. In its middle part, the panel is fitted with a compartment to accommodate the auxiliary instruments of both the units [D]. This solution means the apparatus interfacing with the user is at a convenient height. In the top part of the panel, an additional compartment is available to house any further instruments provided [d].

The arc-proof switchgear is normally fitted with a duct for evacuation of the gases produced by an arc [E].

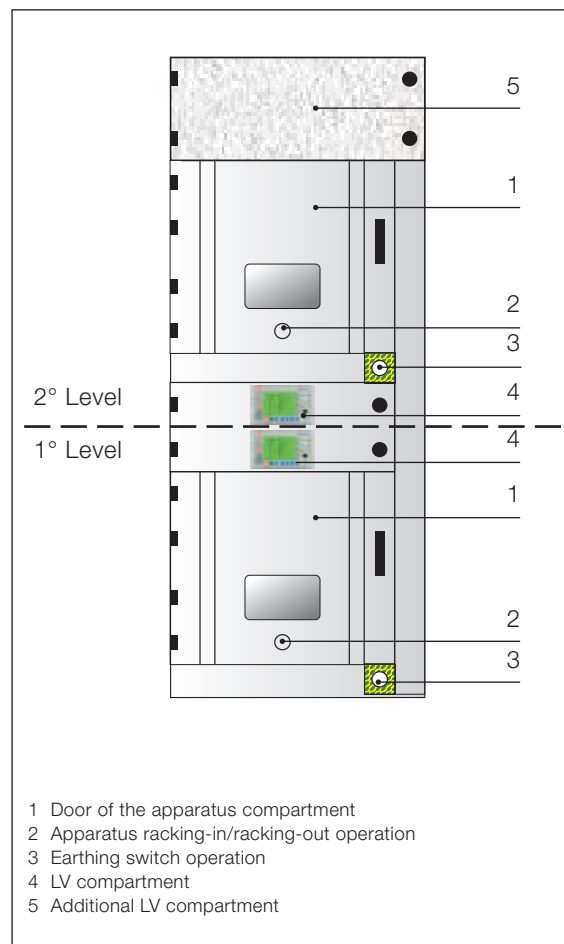
Each compartment of the unit placed on the 2nd level is fitted with a flap on the top surface. The pressure generated by the fault makes this open, allowing the gas to pass into the duct. The gases produced by faults generated in the power compartments of the unit placed on the 1st level are evacuated towards the main duct by means of a dedicated

duct placed laterally to the switchgear [e]. Each compartment of the switchgear panel placed on the 1st level is fitted with a flap positioned on the side of the switchgear. The pressure generated by the fault makes this open, allowing the gas to pass into the duct. This solution means the units placed on the 2nd level are not affected by this fault.

The apparatus compartments are accessible from the front. Door closing of these compartments is available in two versions, with screws or central handle. Removal of the apparatus from the switchgear (circuit-breakers, contactors and measurement truck) placed on the two levels and from its relative compartments, takes place by means of a single dedicated fork-lift truck. This truck can also be used for the same procedures for the single level units.

The busbar and cable compartments are accessible from the rear of the switchgear by means of removable panels.

All the normal service operations are carried out from the front, whereas maintenance and start-up operations also require access from the rear of the switchgear.



The characteristics of the busbar system, branch connections, earthing busbar, earthing switch, insulator bushings and shutters are the same as those for the single level units. A maximum of six single or three-core cables per phase can be used depending on the rated voltage, on the switchgear panel dimensions and on the cross-section of the cables.

Configurations

The typical switchgear panels available allow the most suitable configurations for the installation requirements.

The incoming/outgoing feeder panel [IF] is the most widely used: both switchgear levels consist of units of this type and can be used both as incoming and outgoing feeders.

The bus-tie [BT] and riser [R] units are used to arrange complete double-level switchgear configuration.

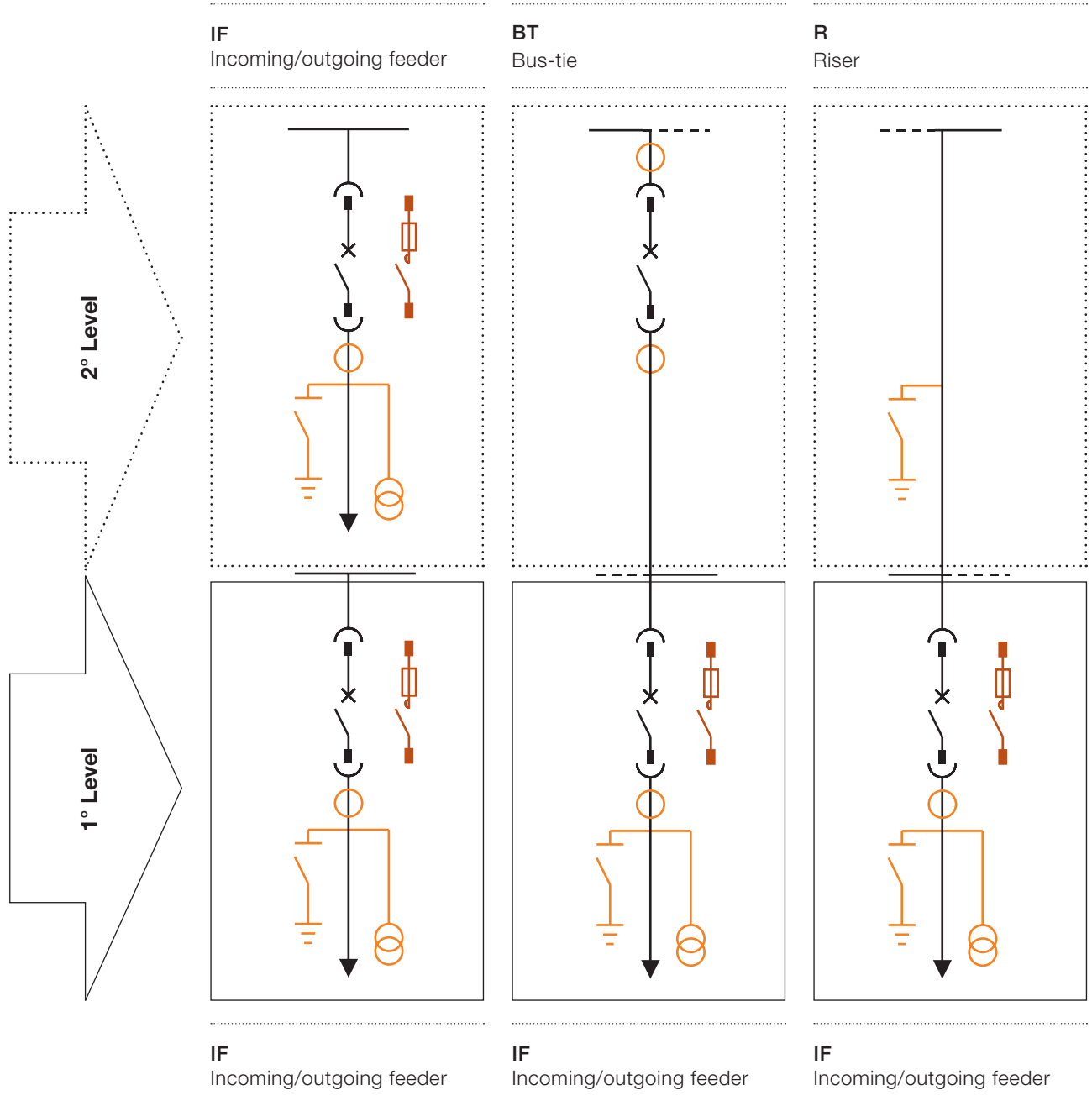
These units are positioned on the 2nd level, whereas the incoming/outgoing feeder units are included in the 1st level.

The bus-tie units can be fitted with current transformers on the load side of the circuit-breaker for busbar measurement. Installation of the current transformers on the supply side is also possible to realise special protection schemes. The riser compartment is also available in the version with withdrawable instrument truck with voltage transformers with fuses [RM]. The mixed configuration with single and double level requires connection between the two sections of switchgear by means of the connection unit. This unit makes all the connections between the two types of switchgear (busbars, earthing busbar, gas exhaust duct, ducts for connection of the auxiliary circuits) and can integrate the earthing switch of the busbars [J] and also the withdrawable instrument truck with voltage transformers with fuses [JM]. These units are positioned on the 2nd level, whereas the incoming/outgoing feeder units are included on the first level.

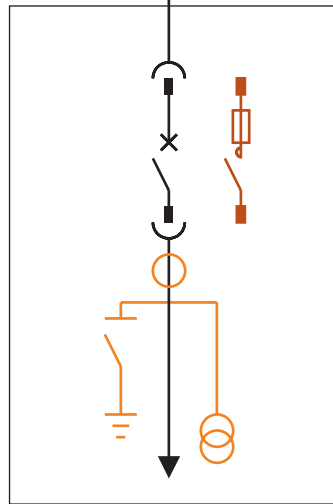
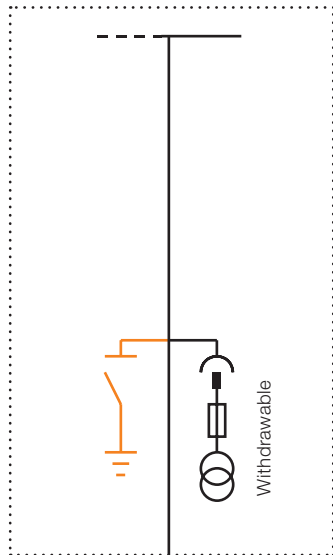


Figure 73: Mixed configuration of UniGear ZS1 single and double level

3. Marine Applications UniGear ZS1 Double Level Typical units

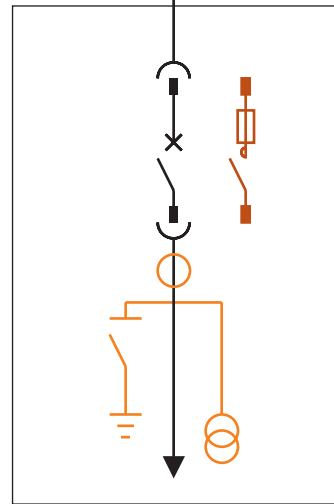
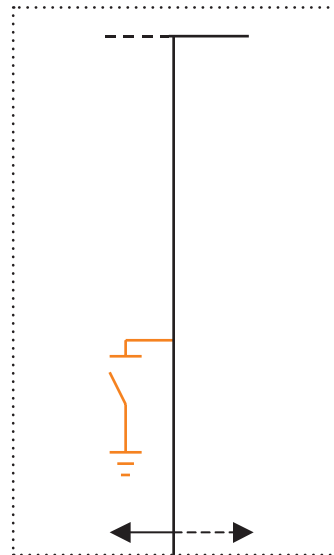


RM
Riser with measurements



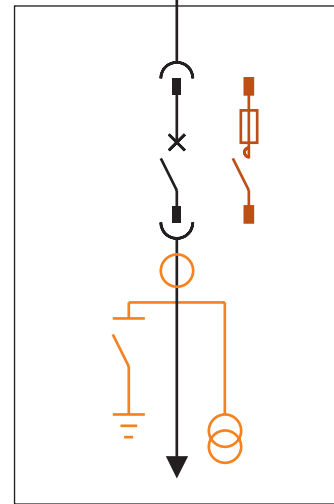
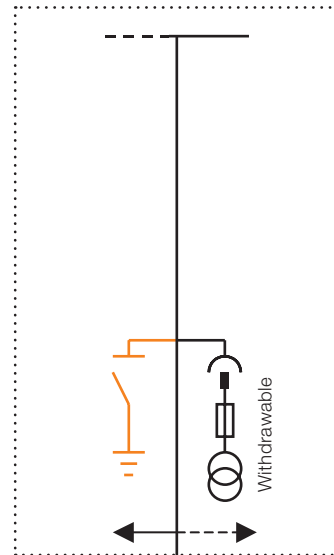
IF
Incoming/outgoing feeder

J
Connection unit



IF
Incoming/outgoing feeder

JM
Connection unit with



IF
Incoming/outgoing feeder

Key to components

- Standard components
- Accessories
- Alternative solutions
- Standard components

3. Marine Applications

UniGear ZS1 Double Level

Technical data

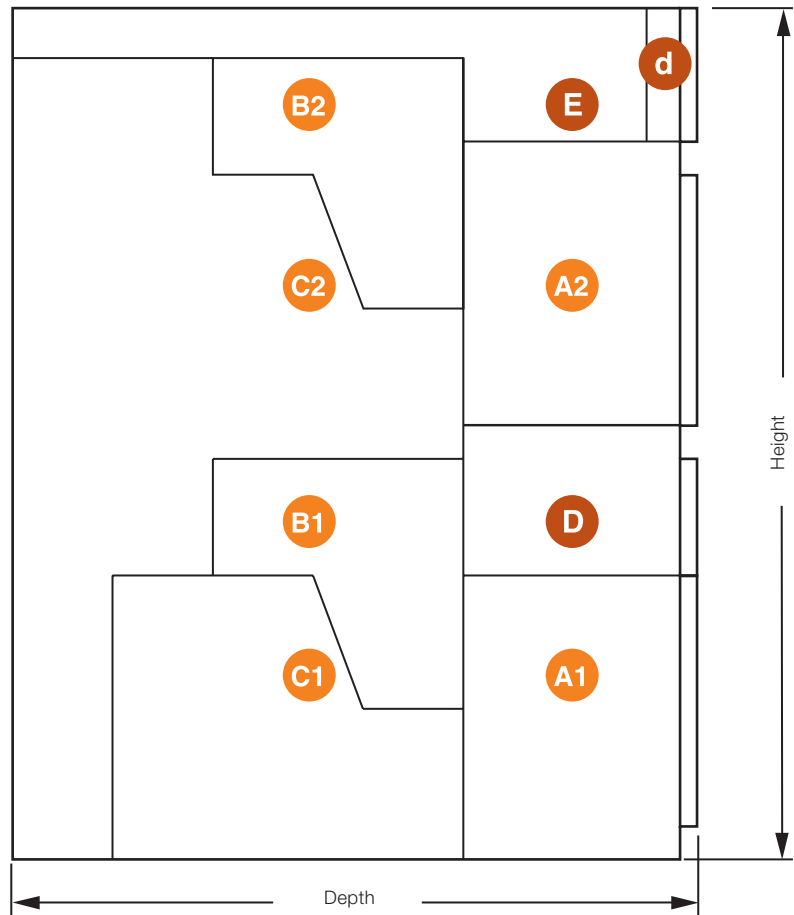
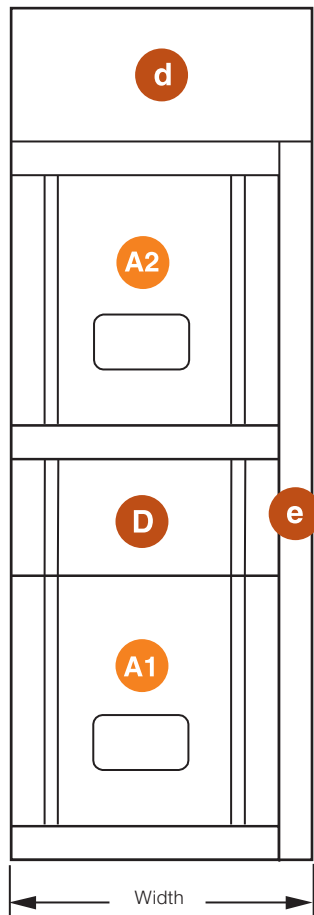
... 12 kV - ... 50 kA

Depth (mm)			1976			
Height (mm)			2700 ⁽¹⁾			
Height with gas exhaust duct (mm)			2700 ⁽¹⁾			
Width (mm)			750	750	900	900
Rated short-time current (kA)			... 31.5	... 31.5	... 50	... 50
Rated current (A)			630	1000	1250	1600
2 nd	IF	Incoming/outgoing	(2)			
1 st	IF	Incoming/outgoing				
2 nd	B T	Bus-tie				
1 st	IF	Incoming/outgoing				
2 nd	R	Riser				
1 st	IF	Incoming/outgoing				
2 nd	R M	Riser with measurements				
1 st	IF	Incoming/outgoing				
2 nd	J	Connection	1250 A			
1 st	IF	Incoming/outgoing	(2)			
2 nd	J M	Connection with measurements	1250 A			
1 st	IF	Incoming/outgoing	(2)			

.... 17.5 kV - ... 40 kA

Depth (mm)			1976			
Height (mm)			2700 (')			
Height with gas exhaust duct (mm)			2700 (')			
Width (mm)			750	750	900	900
Rated short-time current (kA)			... 31.5	... 31.5	... 40	... 40
Rated current (A)			630	1000	1250	1600
2 nd	IF	Incoming/outgoing				
1 st	IF	Incoming/outgoing				
2 nd	B T	Bus-tie				
1 st	IF	Incoming/outgoing				
2 nd	R	Riser				
1 st	IF	Incoming/outgoing				
2 nd	R M	Riser with measurements				
1 st	IF	Incoming/outgoing				
2 nd	J	Connection	1250 A			
1 st	IF	Incoming/outgoing				
2 nd	J M	Connection with measurements	1250 A			
1 st	IF	Incoming/outgoing				

(1) The height of the switchgear in the mixed configuration with single and double level is the same as that of the double level unit
(2) For the characteristics of these units equipped with contactor refer to page 24.



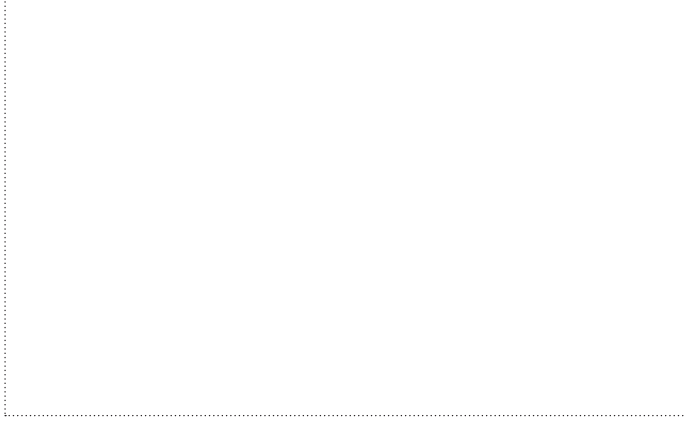
Unit compartments

- A Apparatus compartment
- B Busbar compartment
- C Cable compartment
- D Low voltage compartment
- E Gas duct channel

Notes

A series of horizontal dotted lines for writing notes, spanning the width of the page.

Contact us



Your sales contact: www.abb.com/contacts

More product information: www.abb.com/productguide

The data and illustrations are not binding. We reserve the right to make changes without notice in the course of technical development of the product.

© Copyright 2012 ABB.
All rights reserved.